

# **TR-060**

## **Interoperability test Plan for SHDSL**

**Issue: 2.0**

**Issue Date: February 2005**

## Notice

The Broadband Forum is a non-profit corporation organized to create guidelines for broadband network system development and deployment. This Broadband Forum Technical Report has been approved by members of the Forum. This Broadband Forum Technical Report is not binding on the Broadband Forum, any of its members, or any developer or service provider. This Broadband Forum Technical Report is subject to change, but only with approval of members of the Forum. This Technical Report is copyrighted by the Broadband Forum, and all rights are reserved. Portions of this Technical Report may be copyrighted by Broadband Forum members.

This Broadband Forum Technical Report is provided AS IS, WITH ALL FAULTS. ANY PERSON HOLDING A COPYRIGHT IN THIS BROADBAND FORUM TECHNICAL REPORT, OR ANY PORTION THEREOF, DISCLAIMS TO THE FULLEST EXTENT PERMITTED BY LAW ANY REPRESENTATION OR WARRANTY, EXPRESS OR IMPLIED, INCLUDING, BUT NOT LIMITED TO, ANY WARRANTY:

- (A) OF ACCURACY, COMPLETENESS, MERCHANTABILITY, FITNESS FOR A PARTICULAR PURPOSE, NON-INFRINGEMENT, OR TITLE;
- (B) THAT THE CONTENTS OF THIS BROADBAND FORUM TECHNICAL REPORT ARE SUITABLE FOR ANY PURPOSE, EVEN IF THAT PURPOSE IS KNOWN TO THE COPYRIGHT HOLDER;
- (C) THAT THE IMPLEMENTATION OF THE CONTENTS OF THE DOCUMENTATION WILL NOT INFRINGE ANY THIRD PARTY PATENTS, COPYRIGHTS, TRADEMARKS OR OTHER RIGHTS.

By using this Broadband Forum Technical Report, users acknowledge that implementation may require licenses to patents. The Broadband Forum encourages but does not require its members to identify such patents. For a list of declarations made by Broadband Forum member companies, please see <http://www.broadband-forum.org>. No assurance is given that licenses to patents necessary to implement this Technical Report will be available for license at all or on reasonable and non-discriminatory terms.

ANY PERSON HOLDING A COPYRIGHT IN THIS BROADBAND FORUM TECHNICAL REPORT, OR ANY PORTION THEREOF, DISCLAIMS TO THE FULLEST EXTENT PERMITTED BY LAW (A) ANY LIABILITY (INCLUDING DIRECT, INDIRECT, SPECIAL, OR CONSEQUENTIAL DAMAGES UNDER ANY LEGAL THEORY) ARISING FROM OR RELATED TO THE USE OF OR RELIANCE UPON THIS TECHNICAL REPORT; AND (B) ANY OBLIGATION TO UPDATE OR CORRECT THIS TECHNICAL REPORT.

Broadband Forum Technical Reports may be copied, downloaded, stored on a server or otherwise re-distributed in their entirety only, and may not be modified without the advance written permission of the Broadband Forum.

The text of this notice must be included in all copies.

## Revision History

| <b>Version Number</b> | <b>Date of Last Modification</b> | <b>Changes</b>                                                                                                     |
|-----------------------|----------------------------------|--------------------------------------------------------------------------------------------------------------------|
| Issue 1               | November 2003                    | Broadband Forum membership final ballot approval of TR-060 (WT-079)                                                |
| Issue 2 draft         | 8/10/04                          | Incorporates changes proposed in contribution dsl2004-157.03                                                       |
| Straw Ballot          | 15 October 2004                  | Prepared document as straw ballot based on above contribution and agreement on re-issue approach in dsl2004.310.00 |
| Final Ballot          | Jan 2005                         | Straw ballot comments contained in dsl2004-427 and dsl2004-498 incorporated.                                       |

Technical comments or questions about this Technical Report should be directed to:

Editor: George H. Dobrowski    Conexant Systems, Inc    [george.dobrowski@conexant.com](mailto:george.dobrowski@conexant.com)

**Testing & Interoperability™ Working Group Chairs**

|             |       |
|-------------|-------|
| Les Brown   | TI    |
| Junehee Lee | Aware |

## Table of Contents

|          |                                                                |           |
|----------|----------------------------------------------------------------|-----------|
| <b>1</b> | <b>INTRODUCTION.....</b>                                       | <b>7</b>  |
| <b>2</b> | <b>SCOPE.....</b>                                              | <b>7</b>  |
| <b>3</b> | <b>TEST SETUP .....</b>                                        | <b>8</b>  |
| 3.1      | TYPICAL TEST SETUP .....                                       | 9         |
| 3.2      | STU MONITORING EQUIPMENT .....                                 | 9         |
| 3.3      | TEST LOOPS.....                                                | 10        |
| 3.4      | GROUP TEST TYPICAL SETUP .....                                 | 10        |
| 3.5      | TEST BIT RATES .....                                           | 10        |
| <b>4</b> | <b>TEST PROCEDURE.....</b>                                     | <b>11</b> |
| 4.1      | TEST VALIDATION.....                                           | 11        |
| 4.2      | CONFORMANCE TESTING.....                                       | 11        |
| 4.2.1    | <i>Transmit Power Level.....</i>                               | <i>12</i> |
| 4.2.2    | <i>Power Spectral Density (PSD) Tests .....</i>                | <i>13</i> |
| 4.2.3    | <i>Power Back Off (PBO) Tests .....</i>                        | <i>13</i> |
| 4.2.4    | <i>Impedance of the Transceiver.....</i>                       | <i>15</i> |
| 4.2.5    | <i>Unbalance about Earth – LCL.....</i>                        | <i>15</i> |
| 4.2.6    | <i>Unbalance about Earth – LOV.....</i>                        | <i>16</i> |
| 4.2.7    | <i>Power Feeding and Wetting Current (if implemented).....</i> | <i>16</i> |
| 4.2.7.1  | Wetting Current.....                                           | 16        |
| 4.2.7.2  | Polarity .....                                                 | 16        |
| 4.2.7.3  | Maximum Power Consumption (load).....                          | 17        |
| 4.2.7.4  | Maximum Power Provision (source).....                          | 17        |
| 4.2.7.5  | Reset of the CPE.....                                          | 17        |
| 4.2.7.6  | DC and low frequency AC termination of the NTU .....           | 17        |
| 4.2.8    | <i>Frame BIT Tests.....</i>                                    | <i>18</i> |
| 4.2.8.1  | Frame Bit compatibility.....                                   | 18        |
| 4.2.9    | <i>Overall Activation Test to Reach Data Mode .....</i>        | <i>18</i> |
| 4.3      | PHYSICAL LAYER INTEROPERABILITY .....                          | 21        |
| 4.3.1    | <i>Test Setup.....</i>                                         | <i>21</i> |
| 4.3.2    | <i>Activation– Short Loops.....</i>                            | <i>22</i> |
| 4.3.2.1  | Zero Loop BER Data Transfer .....                              | 22        |
| 4.3.2.2  | Re-Initialisation after Break-Down – Short Loops .....         | 23        |
| 4.3.2.3  | Micro-Interruptions .....                                      | 23        |
| 4.3.2.4  | No Common Mode Test.....                                       | 23        |
| 4.3.3    | <i>Activation Tests Over Various Test Loops.....</i>           | <i>25</i> |
| 4.3.3.1  | Activation – Test Loops Annex A.....                           | 25        |
| 4.3.3.2  | Activation – Test Loops Annex B.....                           | 29        |
| 4.4      | NOISE PERFORMANCE .....                                        | 34        |
| 4.4.1    | <i>Test Configuration .....</i>                                | <i>34</i> |
| 4.4.2    | <i>Test Procedure .....</i>                                    | <i>35</i> |
| 4.4.3    | <i>Expected Result.....</i>                                    | <i>35</i> |

|           |                                                                                |           |
|-----------|--------------------------------------------------------------------------------|-----------|
| 4.5       | LINE PROBE TESTING (RATE ADAPTIVE MODE TESTING)                                | 37        |
| 4.5.1     | <i>Test Configuration</i>                                                      | 37        |
| 4.5.2     | <i>Method of Procedure</i>                                                     | 37        |
| 4.5.3     | <i>Expected Result</i>                                                         | 38        |
| 4.5.4     | <i>Test Configuration</i>                                                      | 39        |
| 4.5.5     | <i>Method of Procedure</i>                                                     | 39        |
| 4.5.6     | <i>Expected Result</i>                                                         | 40        |
| 4.6       | PMMS (PROBE TESTING) COMPLIANCE TESTS                                          | 41        |
| 4.6.1     | <i>PMMS Timing compliance test</i>                                             | 42        |
| 4.6.1.1   | Expected Results                                                               | 42        |
| 4.6.2     | <i>PMMS Signal Compliance Test</i>                                             | 44        |
|           | Test setup                                                                     | 44        |
| 4.6.2.1   | Expected results                                                               | 45        |
| 4.7       | 4-WIRE MODE                                                                    | 45        |
| 4.7.1     | <i>4-Wire Mode start-up description</i>                                        | 45        |
| 4.7.2     | <i>4-Wire Mode start-up description with Lineprobing</i>                       | 46        |
| 4.7.3     | <i>Test Setup</i>                                                              | 48        |
| <b>5</b>  | <b>SYSTEM INTEROPERABILITY</b>                                                 | <b>49</b> |
| 5.1       | LOOP BACK CONTROL STRUCTURE TESTS                                              | 50        |
| 5.1.1     | <i>CO Control Mode</i>                                                         | 50        |
| 5.1.1.1   | CO Control Mode: System Loop back Message (9) Broadcast                        | 50        |
| 5.1.1.1.1 | Network Loop back at Remote                                                    | 50        |
| 5.1.1.1.2 | Customer Loop back at Remote                                                   | 52        |
| 5.1.1.1.3 | Bi-directional Loop back at Remote (If supported by both ends)                 | 53        |
| 5.1.1.1.4 | Special Loop back at Remote (if supported)                                     | 55        |
| 5.1.1.2   | CO Control Mode: Element Loop back Message (10)                                | 56        |
| 5.1.1.2.1 | Network Loop back at Remote                                                    | 56        |
| 5.1.1.2.2 | Customer Loopback at Remote                                                    | 57        |
| 5.1.1.2.3 | Bi-directional Loopback at Remote (If supported by both ends)                  | 59        |
| 5.1.1.2.4 | Special Loopback at Remote (if supported)                                      | 60        |
| 5.1.1.3   | CO Control Mode: CO Loopback: Remote Display                                   | 62        |
| 5.1.1.3.1 | Network Loopback at CO                                                         | 62        |
| 5.1.1.3.2 | Customer Loopback at CO                                                        | 62        |
| 5.1.1.3.3 | Bi-Directional Loopback at CO                                                  | 63        |
| 5.1.2     | <i>Remote Control Mode</i>                                                     | 64        |
| 5.1.2.1   | Remote Control Mode: System Loop back Message (Msg id 9)                       | 64        |
| 5.1.2.1.1 | Network Loop back at CO                                                        | 64        |
| 5.1.2.1.2 | Customer Loopback at CO                                                        | 66        |
| 5.1.2.1.3 | Bi-directional Loopback at CO (if supported by both ends)                      | 67        |
| 5.1.2.1.4 | Network Loopback at Remote using CO control                                    | 69        |
| 5.1.2.1.5 | Customer Loopback at Remote using CO control                                   | 71        |
| 5.1.2.1.6 | Bi-directional Loopback at Remote using CO control (if supported by both ends) | 73        |
| 5.1.2.2   | Remote Control Mode: Element Loop back Message (Msg id 10)                     | 75        |
| 5.1.2.2.1 | Network Loop back at CO                                                        | 76        |
| 5.1.2.2.2 | Customer Loopback at CO                                                        | 77        |

|           |                                                                                          |           |
|-----------|------------------------------------------------------------------------------------------|-----------|
| 5.1.2.2.3 | Bi-directional Loopback at CO (if supported by both ends).....                           | 79        |
| 5.1.2.3   | Remote Control Mode: Remote Loopback: CO Display .....                                   | 80        |
| 5.1.2.3.1 | Network Loop back at Remote .....                                                        | 80        |
| 5.1.2.3.2 | Customer Loop back at Remote.....                                                        | 81        |
| 5.1.2.3.3 | Bi-directional Loop back at Remote (if supported by Remote).....                         | 82        |
| 5.2       | EOC MESSAGING TESTS .....                                                                | 83        |
| 5.2.1     | <i>EOC compatibility</i> .....                                                           | 83        |
| 5.3       | VIRTUAL TERMINAL DISCONNECT TESTS.....                                                   | 90        |
| <b>6</b>  | <b>SHDSL CPE APPLICATION LEVEL TESTING .....</b>                                         | <b>90</b> |
| 6.1       | REQUIRED TEST EQUIPMENT .....                                                            | 90        |
|           | ATM LEVEL TEST .....                                                                     | 91        |
| 6.1.1     | <i>Test purpose</i> .....                                                                | 91        |
| 6.1.2     | <i>Test set-up</i> .....                                                                 | 91        |
| 6.1.3     | <i>ATM Connectivity Tests</i> .....                                                      | 92        |
| 6.1.4     | <i>ATM Interoperability Test description</i> .....                                       | 97        |
| 6.2       | INTEROPERABILITY TEST FOR SHDSL BRIDGES AND ROUTERS.....                                 | 97        |
| 6.2.1     | <i>Test purpose</i> .....                                                                | 97        |
| 6.2.2     | <i>Test set-up</i> .....                                                                 | 97        |
| 6.2.3     | <i>Test description</i> .....                                                            | 98        |
| 6.3       | PERFORMANCE TEST FOR SHDSL BRIDGES AND ROUTERS .....                                     | 99        |
| 6.3.1     | <i>Test purpose</i> .....                                                                | 99        |
| 6.3.2     | <i>Minimum requirements</i> .....                                                        | 99        |
| 6.3.3     | <i>Test set-up</i> .....                                                                 | 99        |
| 6.3.4     | <i>Test description</i> .....                                                            | 99        |
| 6.4       | INTEROPERABILITY TEST FOR SHDSL CPEs WITH CES CAPABILITIES.....                          | 100       |
| 6.4.1     | <i>Test purpose</i> .....                                                                | 100       |
| 6.4.2     | <i>Minimum requirements</i> .....                                                        | 101       |
| 6.4.3     | <i>Test series set-up 1</i> .....                                                        | 101       |
| 6.4.4     | <i>Test Series 1 description</i> .....                                                   | 101       |
| 6.4.5     | <i>Test series set-up 2</i> .....                                                        | 102       |
| 6.4.6     | <i>Test Series 2 description (If equipment is available for such measurements)</i> ..... | 102       |
| 6.4.7     | <i>Test set-up 3</i> .....                                                               | 103       |
| 6.4.8     | <i>Test 3 description</i> .....                                                          | 103       |

## 1 Introduction

This document defines a suite of physical layer tests for SHDSL, ITU G.991.2. The initial intent was to provide a structure for basic vendor-to-vendor interoperability tests, known as “plugfests”. It is expected that the tests contained in this test plan can also be used for inter-system interoperability tests in the course of qualification testing. The primary objective is to ensure that the systems that meet the requirements of the SHDSL are able to pass data.

Sections 1 and 2 provide an introduction and defines the scope of interoperability test plan. The third section describes the test setup requirements. Section 4 defines the test plan for OSI Layer 1. It includes the electrical characteristics at the line interface itself, Power-Back-Off (PBO) and Remote-Power-Feeding capabilities, and test conditions to verify that the Device Under Test (DUT) can reach activation at the physical layer (layer 1 of OSI model). This includes PMD (Physical Media Dependent) and TC (Transmission Convergence) layers, and examination of layer 1 operation on various loop conditions.

Section 5 addresses system interoperability issues at Layer 2 such as loop back control structure, and passing Embedded Operations Channel (EOC) messages between the two systems.

Section 6 introduces test criteria for CPE equipment going beyond the PHY layer to Asynchronous Transfer Mode (ATM) and the Internet Protocol (IP) layer for PPPoA, PPPoE in support of applications such as bridging and IP forwarding by the CPE home bridge/router.

The tests defined in this document focuses primarily on interoperability testing minimal performance criterion of SHDSL.

## 2 Scope

This document describes an SHDSL interoperability test plan covering the following areas:

- Conformance Testing for Electrical Characteristics
- Physical Layer Interoperability Testing (including performance)
- System Interoperability Testing

Section 4 “(Physical Layer Interoperability)” in this document describes a physical layer test plan to test the interoperability of systems designed to meet the ITU SHDSL Recommendation G.991.2 and ETSI TS 101 524. Once the transceivers are able to reach active state, then systems that are designed based on these transceivers should also activate normally. The devices to be tested are referred to as devices under test (DUT) and should have the following features:

1. The DUT can either be span powered or powered from public power mains. In the later case, an external AC-DC power supply can be used to power the board. . If the DUT is line powered, it shall be tested in that mode.
2. The board should have an 8-pin RJ45 socket with pin 4/5 connected to TIP/RING signals for the SHDSL physical interface. Other types of connectors may be used with an appropriate adapter to connect to a RJ45 socket.
3. The board should have a provision to monitor the state of the transceiver by either using a PC or any other display device such as an LCD display or simple LED configuration.
4. The board should be stand alone, performing the activation using a single command. It should not use any development platform during interoperability testing.

### 3 Test setup

TABLE 1: REQUIRED TEST EQUIPMENT

| Test Setup Equipment                  | Model Number/Description                                    | Settings                                                                                                                                                                                                                                |
|---------------------------------------|-------------------------------------------------------------|-----------------------------------------------------------------------------------------------------------------------------------------------------------------------------------------------------------------------------------------|
| Loop Simulator                        | Line simulator with operating instructions manual           | Null loop as well as 9,000 ft of 26 AWG<br>i) Annex A – A.2 Test Loop S, BT1-c/r, BT2-C/r, and C4<br>ii) Annex B.2.2/TS 101 524 test loops #2, #4, #6 and #7 are required                                                               |
| Error Rate Detection/Traffic Analyzer | If using BERT, a tester with operating instructions manual. | Serial bit analyzer: Checking for and detecting Cyclic Redundancy Checks (CRC) errors; Bit Error Rate (BER) measurement capability. Furthermore, when complete systems are to be tested a quality check on Layer 3 could be applicable. |
| STU-R Interface                       |                                                             | CAT-5 < 5 ft cable                                                                                                                                                                                                                      |
| STU-C Interface                       |                                                             | CAT-5 < 5 ft cable                                                                                                                                                                                                                      |
| Impairment Generator                  |                                                             | Capable of generating SHDSL impairment noise.                                                                                                                                                                                           |



|                                               |               |                                                                                                        |
|-----------------------------------------------|---------------|--------------------------------------------------------------------------------------------------------|
|                                               |               | Calibration required.                                                                                  |
| Spectrum Analyzer                             |               | Noise level under – 140dBm/Hz from 25KHz to F <sub>MAX</sub> , High-impedance termination              |
| DSLAM for CPE testing                         | Identify list |                                                                                                        |
| Broadband Access Server (BAS) for CPE testing | List of BASs  | Need to establish protocols and protocol options to be supported as baseline. (RFC2684, PPPoA, PPPoE.) |

### 3.1 Typical Test Setup

A typical test setup is shown in Figure 1 and Figure 2.

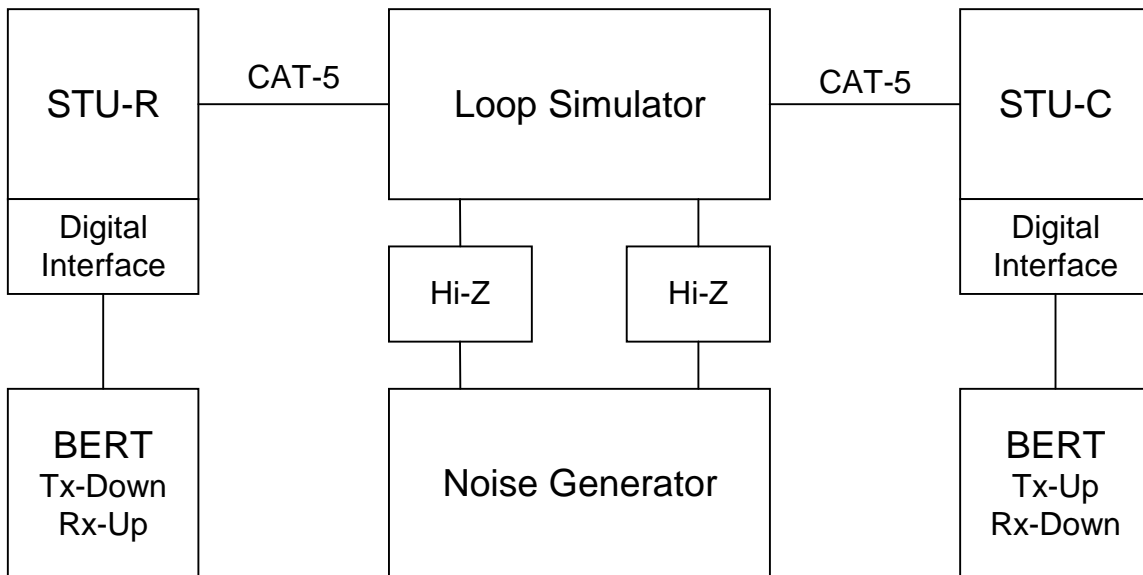

Figure 1: Test Setup

### 3.2 STU Monitoring Equipment

Test participants should provide some basic monitoring and control capability of the STU under test to enable investigation of any faults during testing. The monitoring equipment should provide adequate test monitoring in order that both STU-R and STU-C under test

may be able to determine the cause(s) of any system faults or successes. The specific test procedures listed below indicate what control and monitoring facilities are necessary for each specific test.

It is expected that vendors may provide equipment, for use during testing, that provide the ability to fix observed error conditions causing interoperability failures, so that subsequent testing can continue.

All test monitoring and logging equipment is vendor specific.

**3.3 Test Loops**

The test loops, where specified, should be simulated by a loop simulator. Disturbors, where specified, should be simulated by a noise/impairment generator. All STU interface wiring shall be less than 5 feet of CAT-5 cable or better.

**3.4 Group Test Typical Setup**

A typical test setup for all plugfest tests are as illustrated in Figure 2.

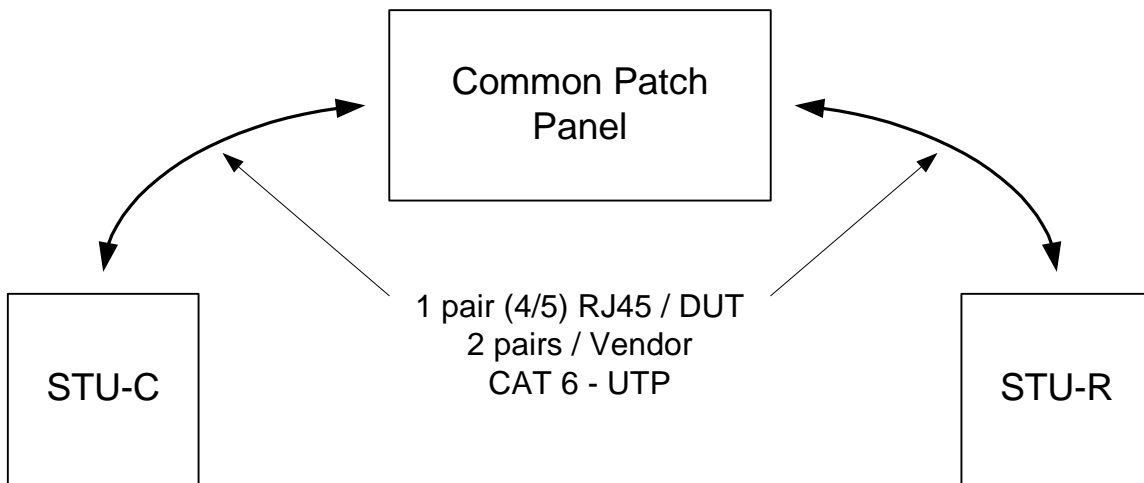

**Figure 2: Plugfest Test Setups**

**3.5 Test Bit Rates**

Table 2 identifies the bit rates to be tested in this test plan. All rates between and including the minimum and the maximum rates of Table 2 supported by the DUT shall be tested.

TABLE 2: BIT RATES

| number of B-channels | number of Z-channels | payload bit rate | resulting line bit rate | Annex Type |
|----------------------|----------------------|------------------|-------------------------|------------|
|----------------------|----------------------|------------------|-------------------------|------------|

|    |   |             |             |         |
|----|---|-------------|-------------|---------|
| 3  | 0 | 192 kbit/s  | 200 kbit/s  | Generic |
| 4  | 0 | 256 kbit/s  | 264 kbit/s  | Generic |
| 6  | 0 | 384 kbit/s  | 392 kbit/s  | Generic |
| 8  | 0 | 512 kbit/s  | 520 kbit/s  | Generic |
| 12 | 0 | 776 kbit/s  | 784 kbit/s  | Generic |
| 16 | 0 | 1024 kbit/s | 1032 kbit/s | Generic |
| 20 | 0 | 1280 kbit/s | 1288 kbit/s | Generic |
| 24 | 0 | 1536 kbit/s | 1544 kbit/s | A       |
| 24 | 0 | 1536 kbit/s | 1544 kbit/s | B       |
| 32 | 0 | 2048 kbit/s | 2056 kbit/s | A       |
| 32 | 0 | 2048 kbit/s | 2056 kbit/s | B       |
| 36 | 0 | 2304 kbit/s | 2312 kbit/s | A       |
| 36 | 0 | 2304 kbit/s | 2312 kbit/s | B       |
| 36 | 1 | 2312 kbit/s | 2320 kbit/s | A       |
| 36 | 1 | 2312 kbit/s | 2320 kbit/s | B       |

Most rates are common between Annexes so they do not have to be differentiated. A few rates such as 1536 payload bit rate/1554 line bit rate, and rates above and including 2048 have specific PSD and Transmit power requirements. These rates must be tested separately.

## 4 Test Procedure

### 4.1 Test Validation

The preferred validation method is to simply inspect the test results during the test with both endpoint STU test application and monitoring equipment. Conveying of the test results is informal. Success is achieved when the corresponding test procedure has been completed and attained the specified success metric. Achievement of the success metric is by agreement between the two endpoint test participants.

The success criteria is 100 percent of all mandatory test cases of a specific Annex. The modem shall respond successfully to an initiation of any test. A failure is understood to be a failure to meet the success criteria included with each test.

### 4.2 Conformance Testing

The tests in this section are to evaluate the electrical characteristics of the line interface. As each system which is operated in an access network means a potential harm to other systems which are operated on adjacent wire pairs in a multi-pair cable the electrical characteristics as specified in SDSL ETSI TS 101 524 and in ITU-T G.991.2 for SHDSL shall be met. The values given in this Section refer to the signal that is applied to the access network at the Network Termination Unit (NTU) port or Line Termination Unit (LTU) port respectively. Tests shall be carried out with one of three different test modes:

- Mode 1: Continuously transmitting mode; the transceiver transmits a PRBS at its maximum transmit power and maximum spectrum until after the line has been disconnected. The modem shall send a pseudo-random data sequence of  $2^{15}-1$  or higher.
- Mode 2: Idle interface mode; the line interface is activated but not transmitting any signal (output level 0 V)
- Mode 3: Data Mode

Figure 3 illustrates the test configuration setup for spectrum testing.

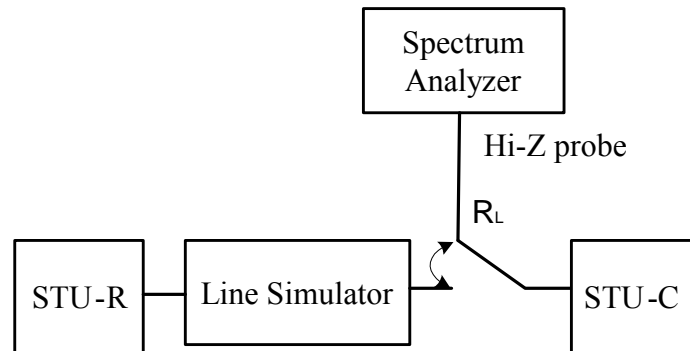

**Figure 3: Spectrum Test Setup**

**4.2.1 Transmit Power Level**

|                        |                                                                                                                                                                                                                                                                                                                                  |
|------------------------|----------------------------------------------------------------------------------------------------------------------------------------------------------------------------------------------------------------------------------------------------------------------------------------------------------------------------------|
| Test Case Identifier   | SH-4210-00                                                                                                                                                                                                                                                                                                                       |
| Test Case Name         | Transmit Power Level                                                                                                                                                                                                                                                                                                             |
| Test Purpose           | To prove that the output level of the SHDSL transceiver does not exceed the maximum allowed transmit value as specified in ITU-T G.991.2 and ETSI TS 101 524                                                                                                                                                                     |
| Standard Requirement   | ITU-T G.991.2: Annex A & B<br><br>ETSI TS 101 524: 9.4                                                                                                                                                                                                                                                                           |
| Test Mode 1            | <ul style="list-style-type: none"> <li>• Continuously transmitting mode</li> </ul>                                                                                                                                                                                                                                               |
| Additional Information | <ul style="list-style-type: none"> <li>▪ Power Measurements have to be performed against a resistive load of 135 Ohms.</li> <li>▪ Use a minimum of 5 kft loop to eliminate PBO</li> </ul>                                                                                                                                        |
| Procedure              | <ul style="list-style-type: none"> <li>• Using the test mode “continuously sending”</li> <li>• Train system at required rate / annex type</li> <li>• Wait until the modem synchronizes</li> <li>• Connect Modem to test setup.</li> <li>• .</li> <li>• Measure the total power generated in <math>R_L</math> within a</li> </ul> |

|                  |                                                                                                                                           |
|------------------|-------------------------------------------------------------------------------------------------------------------------------------------|
|                  | frequency range at least covering the in-band SHDSL signal region.                                                                        |
| Expected Results | <ul style="list-style-type: none"> <li>Annex A &amp; Annex B: Analog Front End transmit power shall be as defined in G.991.2..</li> </ul> |

#### 4.2.2 Power Spectral Density (PSD) Tests

|                        |                                                                                                                                                                                                                                                                                                                                                                                                                                                                                                                                                                                                                                                                                                                                                             |
|------------------------|-------------------------------------------------------------------------------------------------------------------------------------------------------------------------------------------------------------------------------------------------------------------------------------------------------------------------------------------------------------------------------------------------------------------------------------------------------------------------------------------------------------------------------------------------------------------------------------------------------------------------------------------------------------------------------------------------------------------------------------------------------------|
| Test Case Identifier   | SH-4220-00                                                                                                                                                                                                                                                                                                                                                                                                                                                                                                                                                                                                                                                                                                                                                  |
| Test Case Name         | Power Spectral Density                                                                                                                                                                                                                                                                                                                                                                                                                                                                                                                                                                                                                                                                                                                                      |
| Test Purpose           | To prove that the output spectrum of the SHDSL transceiver does not exceed the maximum allowed PSD definition as specified in ITU-T G.991.2 and ETSI TS 101 524; and to test PSD to see if it meets mask after unit is completed                                                                                                                                                                                                                                                                                                                                                                                                                                                                                                                            |
| Standard Requirement   | ITU-T G.991.2:<br>ETSI TS 101 524: 9.4                                                                                                                                                                                                                                                                                                                                                                                                                                                                                                                                                                                                                                                                                                                      |
| Test Mode 1            | <ul style="list-style-type: none"> <li>Continuously transmitting mode</li> </ul>                                                                                                                                                                                                                                                                                                                                                                                                                                                                                                                                                                                                                                                                            |
| Additional Information | <ul style="list-style-type: none"> <li>Power Measurements have to be performed against a resistive load of 135 Ohms</li> <li>Use a minimum of 5 kft loop to eliminate PBO</li> </ul>                                                                                                                                                                                                                                                                                                                                                                                                                                                                                                                                                                        |
| Procedure              | <ul style="list-style-type: none"> <li>Using the test mode “continuously sending”</li> <li></li> <li>Connect Modem to test setup.</li> <li>Train system at required rate / annex type.</li> <li>Measure the PSD generated in <math>R_L</math> with a RBW = 10kHz at frequency range from 1Hz to 1.5MHz</li> </ul> <p>Note: Large PSD variations over narrow frequency intervals (for example near the junction of the main lobe with the noise floor) might require a smaller resolution bandwidth (RBW) to be used. A good rule of thumb is to choose RBW such that there is no more than 1 dB change in the signal PSD across the RBW. It may be necessary to disregard spurious interference peaks observed when using narrow resolution bandwidths.</p> |
| Expected Results       | Annex A & Annex B: PSD shall be within the limits of the PSD Mask as per G.991.2 and ETSI TS 101 524                                                                                                                                                                                                                                                                                                                                                                                                                                                                                                                                                                                                                                                        |

#### 4.2.3 Power Back Off (PBO) Tests

This test is to verify that the Power-Back-Off mechanism is working properly. STU-R and STU-C are connected at both sides of the SHDSL line simulator as depicted in Figure 3. The devices

shall be in normal operational mode. The tests are performed for various loop lengths and various PBO settings specified in Table 3. By using the Element Manager function, the grade of PBO over the loop length is recorded. The spectrum analyzer independently verifies the output power of the device under test.

|                        |                                                                                                                                                                                                                                                                                                                                                                                                             |
|------------------------|-------------------------------------------------------------------------------------------------------------------------------------------------------------------------------------------------------------------------------------------------------------------------------------------------------------------------------------------------------------------------------------------------------------|
| Test Case Identifier   | SH-4230-00                                                                                                                                                                                                                                                                                                                                                                                                  |
| Test Case Name         | PBO measurements                                                                                                                                                                                                                                                                                                                                                                                            |
| Test Purpose           | This test shall be performed at various loop lengths and various PBO settings and verify compliance                                                                                                                                                                                                                                                                                                         |
| Test Mode 3            | <ul style="list-style-type: none"> <li>Data Mode</li> </ul>                                                                                                                                                                                                                                                                                                                                                 |
| Standard Requirement   | ITU-T G.991.2, Section 6.1.5, and ETSI TS 101 524: Section 9.2.6                                                                                                                                                                                                                                                                                                                                            |
| Additional Information | <ul style="list-style-type: none"> <li>STU-R should not set any limits – STU-C will determine the rates and settings</li> <li>Set at the STU-C to the fixed rate to be tested</li> </ul>                                                                                                                                                                                                                    |
| Procedure              | <ul style="list-style-type: none"> <li>Connect modems with SHDSL loop for a loop length of MinL as specified in Table 3, wait for synchronization</li> <li>Measure the total power generated in <math>R_L</math> within a frequency range at least covering the in-band SHDSL signal region.</li> <li>Repeat operation for Delta L (Table 3) loop increments up to 4kft or maximal service reach</li> </ul> |
| Expected Results       | <p>The power back-off that is applied shall be no less than the default power back-off, and it shall not exceed the maximum power back-off value.<br/>See Figure 4<br/>Effective/Expected Power Loss (EPL) is an approximation of the loop attenuation as function of frequency and loop length.</p>                                                                                                        |

TABLE 3: STANDARD SPECIFIC VALUES

| Symbol           | Value        | Description                                    |
|------------------|--------------|------------------------------------------------|
|                  | ITU          |                                                |
| $R_L$            | 135 $\Omega$ | Source or load impedance                       |
| $F_{MAX}$        | 1.5 MHz      | SHDSL bandwidth                                |
| SHDSL Test cases | 1 - 135      | Loop used for performances test                |
| MinL             | 0 kft        | Minimal loop length to start performances test |
| DeltaL           | 500ft        | Loop increment for performances tests          |
|                  |              |                                                |

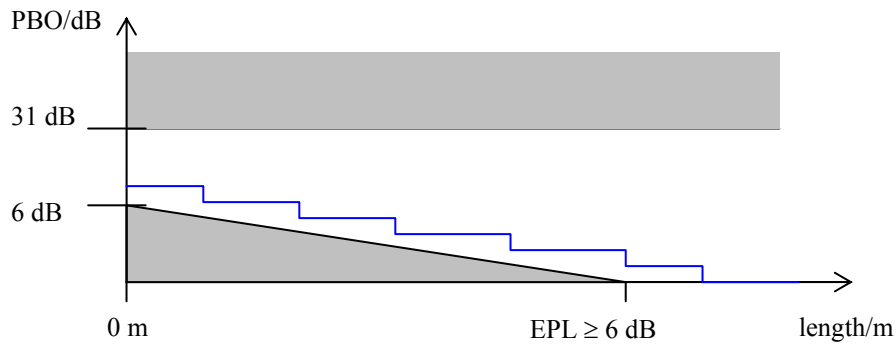

**Figure 4: Example result of PBO over Length measurement**

**4.2.4 Impedance of the Transceiver**

|                        |                                                                                                                                  |
|------------------------|----------------------------------------------------------------------------------------------------------------------------------|
| Test Case Identifier   | SH-4240-00                                                                                                                       |
| Test Case Name         | Impedance of the Transceiver                                                                                                     |
| Test Purpose           | This test shall verify that the load/source impedance of the transceiver is met. As compliance criteria the return loss is used. |
| Standard Requirement   | ITU-T G.991.2 Section 11.3 □ ETSI TS 101 524: Section 11.2                                                                       |
| Additional Information | This test is to be done only at the maximum bit rate.                                                                            |

**4.2.5 Unbalance about Earth – LCL**

|                        |                                                                                                                                                                                                                   |
|------------------------|-------------------------------------------------------------------------------------------------------------------------------------------------------------------------------------------------------------------|
| Test Case Identifier   | SH-4250-00                                                                                                                                                                                                        |
| Test Case Name         | Longitudinal Conversion Loss                                                                                                                                                                                      |
| Test Purpose           | With this test the unbalance about earth is tested with respect to the grade of common-mode signals converting to differential-mode signals.                                                                      |
| Test Mode 2            | Use Idle Interface Mode                                                                                                                                                                                           |
| Standard Requirement   | ITU-T G.991.2 Section 11.1 □ ETSI TS 101 524: Section 11.2                                                                                                                                                        |
| Additional Information | If the device under test does (DUT) not provide a ground connection the DUT must be placed on a earthed ground plate of sufficient size during the test.<br>This test is to be done only at the maximum bit rate. |

#### 4.2.6 Unbalance about Earth – LOV

|                        |                                                                                                                                                         |
|------------------------|---------------------------------------------------------------------------------------------------------------------------------------------------------|
| Test Case Identifier   | SH-4260-00                                                                                                                                              |
| Test Case Name         | Longitudinal Output Voltage                                                                                                                             |
| Test Purpose           | With this test the unbalance about earth is tested with respect to the portion of the transmitted signal which converts to common-mode.                 |
| Test Mode 1            | Continuously Transmitting Mode                                                                                                                          |
| Standard Requirement   | ITU-T G.991.2 Section 11.2 □ ETSI TS 101 524: 11.3.2                                                                                                    |
| Additional Information | If the device under test does (DUT) not provide a ground connection the DUT must be placed on a earthed ground plate of sufficient size during the test |

#### 4.2.7 Power Feeding and Wetting Current (if implemented)

Several network operators require remote power feeding. In those networks, power feeding issues have a vital meaning for interoperability. The following tests shall ensure interoperability on the DC remote power feeding level for SHDSL systems. These are derived from Recommendation G.991.2 Annex A & B, and ETSI TS 101 524. Remote Power Feeding is not a mandatory requirement, but if remote power feeding is implemented, its functionality is to be tested according to this section.

##### 4.2.7.1 Wetting Current

|                        |                                                                                                                                                                                                                                                                                 |
|------------------------|---------------------------------------------------------------------------------------------------------------------------------------------------------------------------------------------------------------------------------------------------------------------------------|
| Test Case Identifier   | SH-4271-00                                                                                                                                                                                                                                                                      |
| Test Case Name         | Remote Power Feeding; Wetting Current                                                                                                                                                                                                                                           |
| Test Purpose           | With this test it is verified, that the STU-R (or SRU-R) is able to draw between 1 and 20 mA for Annex A and up to a maximum of 10 mA for Annex B/TS 101 524 of wetting (sealing) current from the remote feeding circuit when span powering is disabled or is not supported. . |
| Standard Requirement   | ITU-T G.991.2 section A.5.3.3, B.5.3.2<br>ETSI TS 101 524: Section 13.2                                                                                                                                                                                                         |
| Additional Information | To show conformity to this requirement an STU-C is required which provides remote power feeding and which is configured to provide wetting current.                                                                                                                             |

##### 4.2.7.2 Polarity

|                        |                                                                                                                                                      |
|------------------------|------------------------------------------------------------------------------------------------------------------------------------------------------|
| Test Case Identifier   | SH-4272-00                                                                                                                                           |
| Test Case Name         | Remote Power Feeding; Polarity                                                                                                                       |
| Test Purpose           | With this test it is verified, that the STU-R (or SRU) is able to operate normally when the dc remote power feeding is provided with either polarity |
| Standard Requirement   | ITU-T G.991.2 section A.5.3.2.2:<br>ETSI TS 101 524: Section 13.5.1                                                                                  |
| Additional Information | To show conformity to this requirement an STU-C is required which provides remote power feeding.                                                     |



**4.2.7.3 Maximum Power Consumption (load)**

|                        |                                                                                                                                                                                                                                                                                                                                                                                                                                                                                                                       |
|------------------------|-----------------------------------------------------------------------------------------------------------------------------------------------------------------------------------------------------------------------------------------------------------------------------------------------------------------------------------------------------------------------------------------------------------------------------------------------------------------------------------------------------------------------|
| Test Case Identifier   | SH-4273-00                                                                                                                                                                                                                                                                                                                                                                                                                                                                                                            |
| Test Case Name         | Maximum Power when life line is provided (Annex B only)                                                                                                                                                                                                                                                                                                                                                                                                                                                               |
| Test Purpose           | The maximum power drawn by the SHDSL NTU when the local power fails and lifeline service has to be provided is 2.1 W                                                                                                                                                                                                                                                                                                                                                                                                  |
| Standard Requirement   | ITU-T G.991.2 (Section B.);<br>ETSI TS 101 524: Section 13.5.1                                                                                                                                                                                                                                                                                                                                                                                                                                                        |
| Additional Information | To show conformity to this requirement an STU-C is required which provides remote power feeding.<br><br>Note: In order to enhance the performance in the critical conditions (longest loops and lower input voltages) and to avoid giving unnecessary burden to the design of the NTU, compliance to the 2.1 W limit is requested only when the NTU input voltage is <70 V. With the NTU input voltages higher than 70 V (short loops and higher LTU feeding voltages), a power consumption up to 2.5 W is permitted. |

**4.2.7.4 Maximum Power Provision (source)**

|                        |                                                                                                                                      |
|------------------------|--------------------------------------------------------------------------------------------------------------------------------------|
| Test Case Identifier   | SH-4274-00                                                                                                                           |
| Test Case Name         | Maximum Power Consumption (source)                                                                                                   |
| Test Purpose           | With this test it is verified, that the CO equipment (feeding device) does not provide more than 60 mA, independently from the load. |
| Standard Requirement   | ITU-T G.991.2 (Section A.5.3.1.2)<br><br>ETSI TS 101 524: Section 13.4                                                               |
| Additional Information |                                                                                                                                      |

**4.2.7.5 Reset of the CPE**

|                        |                                                                                                                                                   |
|------------------------|---------------------------------------------------------------------------------------------------------------------------------------------------|
| Test Case Identifier   | SH-4275-00                                                                                                                                        |
| Test Case Name         | Reset of CPE (Annex B only)                                                                                                                       |
| Test Purpose           | With this test it is verified, that the CPE does enter a reset state not later than 2 seconds after DC remote power feeding is interrupted.       |
| Standard Requirement   | ITU-T G.991.2 (Section B.)<br><br>ETSI TS 101 524: Section 13.5.3                                                                                 |
| Additional Information | This functionality has to be investigated for several conditional parameters (line length, feeding voltage, CPE activated, CPE deactivated, etc.) |

**4.2.7.6 DC and low frequency AC termination of the NTU**

|                        |                                                                                                                                                                                                                                                                                                                                                                                                                       |
|------------------------|-----------------------------------------------------------------------------------------------------------------------------------------------------------------------------------------------------------------------------------------------------------------------------------------------------------------------------------------------------------------------------------------------------------------------|
| Test Case Identifier   | SH-4276-00                                                                                                                                                                                                                                                                                                                                                                                                            |
| Test Case Name         | Reset of CPE                                                                                                                                                                                                                                                                                                                                                                                                          |
| Test Purpose           | With this test it is verified, that the CPE equipment does enter a high impedance state within 2 seconds after DC remote power feeding current is interrupted. Furthermore it is verified that this state is maintained as long as the line voltage (DC + AC peak) does not exceed 18 V. It is investigated that the leakage current in this state is less than 10 uA and the input capacitance is greater than 2 uF. |
| Standard Requirement   | ITU-T G.991.2 Section 11, :□ETSI TS 101 524: Section 13.6                                                                                                                                                                                                                                                                                                                                                             |
| Additional Information | This functionality has to be investigated for several conditional parameters (line length, feeding voltage, CPE activated, CPE deactivated, etc.)                                                                                                                                                                                                                                                                     |

#### 4.2.8 Frame BIT Tests

Frame bits and paragraph References are from ITU-T G.991.2 (02/2001) & Amendment 1 (11/2001).

The frame bit enables an immediate check of the SHDSL loop conditions. LOSD (Loss of Signal) bit is vendor specific and should not be part of the SHDSL interoperability test document due to the fact that the receiver does not know the cause for the fault.

##### 4.2.8.1 Frame Bit compatibility

Frame bit PS as defined in section 7.1.2.5.3. This includes verification of:

1. fbit3 = ps (Power Status)
  - Generate loss of power on the STU-R and verify that the ps bit is set accordingly.

Frame bit SEGA as defined in section 7.1.2.5.2. This includes verification of:

2. fbit2 = sega (Segment Anomaly)
  - Generate CRC errors on the SHDSL loop and verify that the sega bit is set accordingly.

Frame bit SEGD as defined in section 7.1.2.5.4. This includes verification of:

3. fbit4 = segd (Segment Defect)
  - Generate loss of sync and verify that the segd bit is set accordingly.

#### 4.2.9 Overall Activation Test to Reach Data Mode

Table 4 is from G.991.2 and identifies the timing requirements for the activation signals. However, the activation timing test can be a simplified to an overall verification that the SHDSL

modem reaches data mode without having to verify each activation signal. To determine what would be the appropriate amount of time for the overall activation test, need to consider the following points:

- There is no global timing requirement for Handshake specified in G.994.1. A time of 5 seconds is proposed as a typical time to be added to the activation times and reach data mode.
- Reliable data shall be attained within 5 minutes per G.991.2, A3.1.5
- A final consideration, the standards do not place a limit on the number of times Activation and Handshake can take place. For purposes of this test, it is proposed that the overall time requirement be based on a single try for the fixed rate case. For rate adaptive, a second Handshake sequence needs to be factored into the overall time.

Overall activation time is therefore based on the sum of the various times from Table 4, plus 5 seconds for handshake.

At the completion of activation and handshake, look for zero bit error transmission for at least 30 seconds. Reliable data exchange can take up to 5 minutes per G.991.2.

The test shall be performed with the noise generator removed or turned off. The devices shall be in normal operational mode. The test only needs to be performed on a single straight loop. It is not necessary to repeat the test for the data rates and loop lengths specified in Tables 5, 6 and 7 since interoperation at all the rates and loop conditions will be verified in other tests. It is recommended that a 9 kft straight AWG26 wire loop be used.

TABLE 4. TIMING FOR ACTIVATION SIGNALS

| Time                                                                                                                          | Parameter                                    | Nominal Value          | Tolerance   |
|-------------------------------------------------------------------------------------------------------------------------------|----------------------------------------------|------------------------|-------------|
| $t_{cr}$                                                                                                                      | Duration of $C_r$                            | $1 \times \beta$ s *   | $\pm 20$ ms |
| $t_{crsc}$                                                                                                                    | Time from end of $C_r$ to beginning of $S_c$ | 500 ms                 | $\pm 20$ ms |
| $t_{crsr}$                                                                                                                    | Time from end of $C_r$ to beginning of $S_r$ | $1.5 \times \beta$ s * | $\pm 20$ ms |
| $t_{Act}$                                                                                                                     | Maximum time from start of $C_r$ to $Data_r$ | $15 \times \beta$ s *  |             |
| * $\beta$ is dependent on bit rate. $\beta=1$ for $n>12$ , $\beta=2$ for $n \leq 12$ , where $n$ is the number of B channels. |                                              |                        |             |

|                      |                                                                                                                                                            |
|----------------------|------------------------------------------------------------------------------------------------------------------------------------------------------------|
| Test Case Identifier | SHDSL-4290-10                                                                                                                                              |
| Test Case Name       | Compliance to overall activation timing                                                                                                                    |
| Test Purpose         | This test shall be performed to verify compliance with activation and handshake timing to enter data mode                                                  |
| Standard Requirement | ITU-T G.991.2 Section 6.2.2, and Section 6.3.2 for Rate Adaptive Power Measurement Modulation Session (PMMS) or line probe; ETSI TS 101 524: Section 9.1.2 |

|                        |                                                                                                                                                                                                                                                                                                                                                                                                                                                                        |
|------------------------|------------------------------------------------------------------------------------------------------------------------------------------------------------------------------------------------------------------------------------------------------------------------------------------------------------------------------------------------------------------------------------------------------------------------------------------------------------------------|
| Additional Information | <ul style="list-style-type: none"> <li>• STU-R should not set any limits – STU-C will determine the rates and settings</li> <li>• Set at the STU-C to the fixed rate to be tested</li> </ul>                                                                                                                                                                                                                                                                           |
| Procedure              | <ul style="list-style-type: none"> <li>• Connect modems with 9 kft straight AWG26 loop with the noise turned off.</li> </ul>                                                                                                                                                                                                                                                                                                                                           |
| Expected Results       | <p>Fixed Rate:</p> <ul style="list-style-type: none"> <li>• <math>N \leq 12</math>, reach data mode 35.5 seconds +/- 0.5s</li> <li>• <math>N &gt; 12</math>, reach data mode in 23s +/- 0.5s</li> </ul> <p>Rate Adaptive (includes additional 5s for second HS and 10s for PMMS):</p> <ul style="list-style-type: none"> <li>• <math>N \leq 12</math>, reach data mode in 55.5s +/- 0.5s</li> <li>• <math>N &gt; 12</math>, reach data mode in 38s +/- 0.5s</li> </ul> |

Test case SHDSL-4290-20 verifies that the Activation times are within the specified tolerances. STU-R and STU-C are connected at both sides of the SHDSL line simulator as depicted in Figure 5. The noise generator is removed or turned off. The devices shall be in normal operational mode. The tests are performed for the data rates and loop lengths specified in Table 3 for the “S” loops (i.e. only for straight AWG26 wire loop). The storage oscilloscope is used to record the activation sequence, from which the activation times can be measured. Figure 5 shows the location of the oscilloscope.

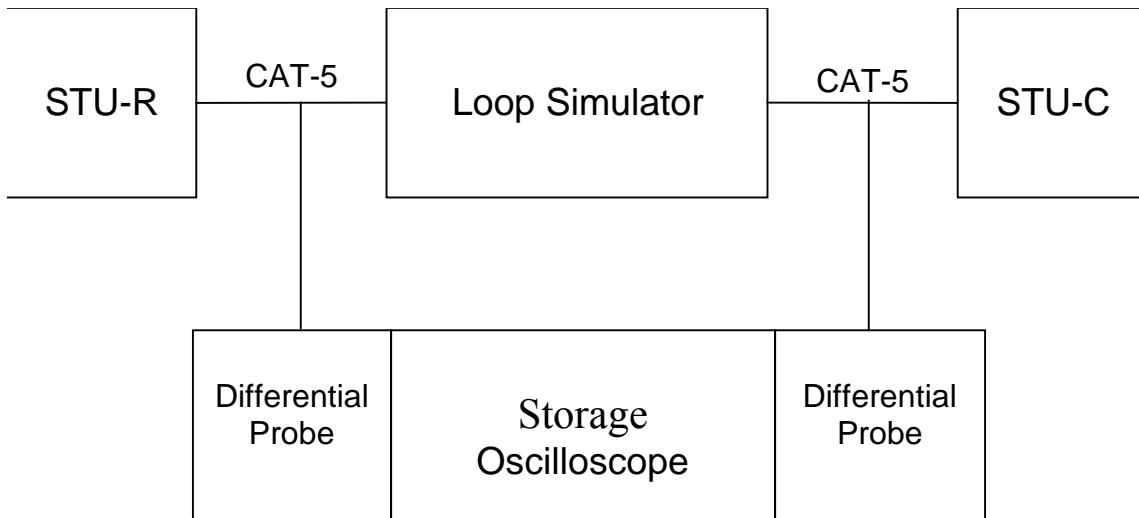

**Figure 5. Set-up to check activation timing**

|                        |                                                                                                                                                                                                                                                                                                                                                                                                                                                                                                                                                                                                                                                                                                                                                                                                                                                                                                                                                                                                     |
|------------------------|-----------------------------------------------------------------------------------------------------------------------------------------------------------------------------------------------------------------------------------------------------------------------------------------------------------------------------------------------------------------------------------------------------------------------------------------------------------------------------------------------------------------------------------------------------------------------------------------------------------------------------------------------------------------------------------------------------------------------------------------------------------------------------------------------------------------------------------------------------------------------------------------------------------------------------------------------------------------------------------------------------|
| Test Case Identifier   | SHDSL-4290-20                                                                                                                                                                                                                                                                                                                                                                                                                                                                                                                                                                                                                                                                                                                                                                                                                                                                                                                                                                                       |
| Test Case Name         | Compliance to activation timing parameters                                                                                                                                                                                                                                                                                                                                                                                                                                                                                                                                                                                                                                                                                                                                                                                                                                                                                                                                                          |
| Test Purpose           | This test shall be performed for the 2048, 1544, 768 and 384kbps rates and verify compliance                                                                                                                                                                                                                                                                                                                                                                                                                                                                                                                                                                                                                                                                                                                                                                                                                                                                                                        |
| Standard Requirement   | ITU-T G.991.2 Section 6.2.2, and ETSI TS 101 524: Section 9.1.2                                                                                                                                                                                                                                                                                                                                                                                                                                                                                                                                                                                                                                                                                                                                                                                                                                                                                                                                     |
| Additional Information | <ul style="list-style-type: none"> <li>• STU-R should not set any limits – STU-C will determine the rates and settings</li> <li>• Set at the STU-C to the fixed rate to be tested</li> </ul>                                                                                                                                                                                                                                                                                                                                                                                                                                                                                                                                                                                                                                                                                                                                                                                                        |
| Procedure              | <ul style="list-style-type: none"> <li>• Connect modems with SHDSL loop for a loop length of L as specified in Table 5. Only the loop types S are to be tested (i.e straight AWG26) with the noise turned off.</li> <li>• The oscilloscope setup for the activation timing test will vary depending upon the make and model. However, an appropriate sweep time and sampling rate should be used to ensure that the entire training sequence of up to 30 seconds is stored. With this criteria met, the user will be able to allow the oscilloscope to free run until the units achieve data. Then the storage oscilloscope should be stopped so that the training sequence can be reviewed for compliance. The activation times can be verified through the use of the measurement functions of the oscilloscope. The T_Act measurement will begin at Cr and terminate when the signal transitions from two level to sixteen level PAM.</li> <li>• Measure t_cr, t_crsc, t_crsr, t_Act.</li> </ul> |
| Expected Results       | The recorded values should be within the tolerances specified in the Table 4.                                                                                                                                                                                                                                                                                                                                                                                                                                                                                                                                                                                                                                                                                                                                                                                                                                                                                                                       |

### 4.3 Physical Layer Interoperability

The tests given in section 4.3, 4.4, and 4.4-5 are intended to investigate the initialization procedures during plugfests. It is expected that – after physical layer interoperability at the transceiver level is achieved – this tests could be reduced to a simpler set of activation tests on a system/implementation basis. Hence, when system tests are to be performed, Section 5 applies.

#### 4.3.1 Test Setup

Figure 6 depicts the test setup for the tests of this section. This test will assure that all supported rates will be able to pass data. The mode of operation (MO) may be different for each modem, but both STU-C and STU-R must use compatible modes. The MO should be pre-selected prior to tests.

Mode of operations:

1. Clear channel Synchronous
2. Clear channel Plesiochronous
3. Fractional E1 Plesiochronous
4. Fractional T1 Plesiochronous
5. ATM Synchronous

Mode of operation to be tested will be determined per system.

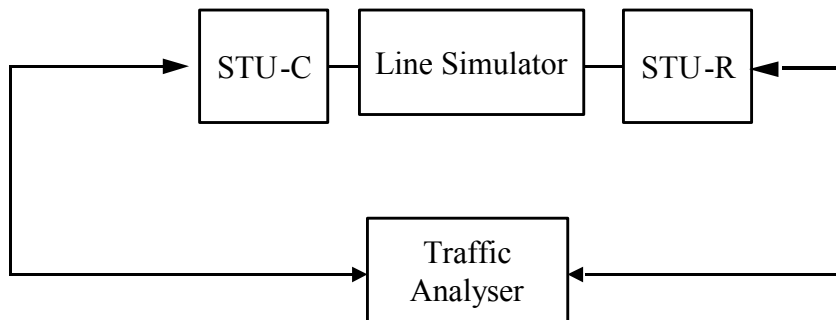

**Figure 6: Test Setup**

#### 4.3.2 Activation– Short Loops

##### 4.3.2.1 Zero Loop BER Data Transfer

For this test the two systems are connected over a Zero-Loop. Criteria for passing this test is the achievement of steady transmission with a bit error rate  $BER < 10^{-7}$  over the Zero-Loop. As the test is done by using an IP connection (Layer 3 performance) bit error rate is calculated on IP packet basis. . A minimum of  $10^8$  bits should be passed for this test.

|                        |                                                                                                                                                                                                                                                                                                                                     |
|------------------------|-------------------------------------------------------------------------------------------------------------------------------------------------------------------------------------------------------------------------------------------------------------------------------------------------------------------------------------|
| Test Case Identifier   | SH-4321-00                                                                                                                                                                                                                                                                                                                          |
| Test Case Name         | Zero Loop BER Data Transfer                                                                                                                                                                                                                                                                                                         |
| Test Purpose           | With this test it is verified, that two systems do achieve steady transmission state after a reasonable time when they are linked to each other over a Zero-Loop. Transmission quality is taken as pass/fail criteria. With this test it is proven, that systems do not enter a overload condition when they are used back-to-back. |
| Standard Requirement   | ITU-T G.991.2 (Section 6.1.5): □ ETSI TS 101 524: Section 12.3                                                                                                                                                                                                                                                                      |
| Additional Information | The test shall be performed at bit rates contained in Table 2. When asymmetric PSD is supported, additional test with asymmetric PSD is to be performed.                                                                                                                                                                            |
| Expected Results       | A minimum of $10^8$ bits should be passed for this test with a bit error rate $BER < 10^{-7}$                                                                                                                                                                                                                                       |

#### 4.3.2.2 Re-Initialisation after Break-Down – Short Loops

For this test the two systems are connected over a Zero-Loop. Criteria for passing this test is the re-achievement of steady transmission over the Zero-Loop after Loop-Break-Down.

|                        |                                                                                                                                                                                        |
|------------------------|----------------------------------------------------------------------------------------------------------------------------------------------------------------------------------------|
| Test Case Identifier   | SH-4322-00                                                                                                                                                                             |
| Test Case Name         | Re-Initialisation after Break-Down; Short Loop                                                                                                                                         |
| Test Purpose           | With this test it is verified, that two systems do re-achieve steady transmission state after a Loop-Break-Down in reasonable time when they are linked to each other over a Zero-Loop |
| Standard Requirement   | ITU-T G.991.2 (Section 12.1): □ ETSI TS 101 524: Section 12.3                                                                                                                          |
| Additional Information | The test shall be performed at the bit rate contained in Table 2. When asymmetric PSD is supported, additional test with asymmetric PSD is to be performed.                            |

#### 4.3.2.3 Micro-Interruptions

For this test the two systems are connected over a test loop. Criteria for passing this test is the re-achievement of steady transmission over the test loop after micro-interruptions occur.

|                        |                                                                                                                                                                                                                  |
|------------------------|------------------------------------------------------------------------------------------------------------------------------------------------------------------------------------------------------------------|
| Test Case Identifier   | SH-4323-00                                                                                                                                                                                                       |
| Test Case Name         | Micro-Interruptions                                                                                                                                                                                              |
| Test Purpose           | With this test it is verified, that two end points do re-achieve steady transmission state after a micro-interruption in reasonable time when they are linked to each other over a 5000 foot – 26 AWG test loop. |
| Standard Requirement   | ITU-T G.991.2 (Section 12.1): □ ETSI TS 101 524: Section 12.3                                                                                                                                                    |
| Additional Information | The test shall be performed at the maximum supported bit rate. The interrupt shall have a break time of 10 ms with the signal period = 5 S for a total test interval of 60 seconds.                              |
| Expected Results       | Achieve steady transmission over the test loop after micro-interruptions occur                                                                                                                                   |

#### 4.3.2.4 No Common Mode Test

Purpose of this test is to verify the correct Handshake procedure in case no common mode can be achieved. This enables the upper layers to detect such an event in case of an activation failure.

**Test Setup:** STU-R and STU-C are connected together as depicted in Figure 7. The storage oscilloscope is used to record the preactivation sequence. The loop simulator should be set to 1000m with no noise.

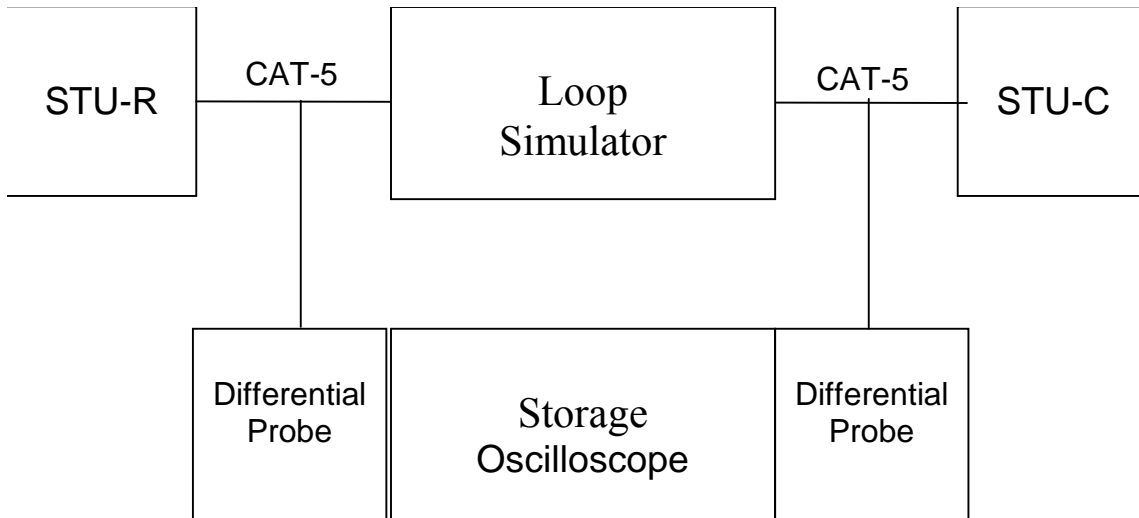

**Figure 7: Set-up to check no common mode**

|                        |                                                                                                                                                                                                                                                                                                                                                                                                                                                                                                                                                                                                                                                                                                                                          |
|------------------------|------------------------------------------------------------------------------------------------------------------------------------------------------------------------------------------------------------------------------------------------------------------------------------------------------------------------------------------------------------------------------------------------------------------------------------------------------------------------------------------------------------------------------------------------------------------------------------------------------------------------------------------------------------------------------------------------------------------------------------------|
| Test Case Identifier   | SH-4324-00                                                                                                                                                                                                                                                                                                                                                                                                                                                                                                                                                                                                                                                                                                                               |
| Test Case Name         | No Common Mode Test                                                                                                                                                                                                                                                                                                                                                                                                                                                                                                                                                                                                                                                                                                                      |
| Test Purpose           | Test the correct Handshake procedure in case of no common mode.                                                                                                                                                                                                                                                                                                                                                                                                                                                                                                                                                                                                                                                                          |
| Standard Requirement   | ITU-T G.994.1 Section 10.1                                                                                                                                                                                                                                                                                                                                                                                                                                                                                                                                                                                                                                                                                                               |
| Additional Information | If the STU-R or the STU-C cannot determine a common mode of operation from previous capabilities exchanges, or is not prepared to select a mode at this time, it shall send an MS message with the Non-standard field bit of the Identification field NPar(1) and all coding points (Standard information fields NPar(1), Spar(1)_1, Spar(1)_2, Spar(1)_3 and Spar(1)_4) set to binary ZERO. When the STU-C or STU-R receives this MS message, it shall respond with an ACK(1) message. The STU-R or the STU-C shall then initiate the clear down procedure (ITU-T G.994.1 Section 11.3), and shall return to the initial state, i.e. R-SILENT0 for HSTU-R, C-SILENT1 for HSTU-C of the start-up procedure (ITU-T G.994.1 Section 11.2). |
| Procedure              | <ul style="list-style-type: none"> <li>• Connect modems.</li> <li>• Send a CL list to the tested modem which would result in a no common operation mode, e.g.             <ul style="list-style-type: none"> <li>- different annex selected :                 <ul style="list-style-type: none"> <li>▪ STU-R Annex A</li> <li>▪ STU-C Annex B</li> </ul> </li> <li>- mismatch of the selected data rates.</li> </ul> </li> <li>• The oscilloscope setup for the preactivation timing test will</li> </ul>                                                                                                                                                                                                                                |



|                  |                                                                                                                                                                                                                                                                                                                                                                                                                                                                                                                                                                                                                                                                                                                     |
|------------------|---------------------------------------------------------------------------------------------------------------------------------------------------------------------------------------------------------------------------------------------------------------------------------------------------------------------------------------------------------------------------------------------------------------------------------------------------------------------------------------------------------------------------------------------------------------------------------------------------------------------------------------------------------------------------------------------------------------------|
|                  | <p>vary depending upon the make and model. However, an appropriate sweep time and sampling rate should be used to ensure that the entire preactivation sequence of up to 8 seconds is stored. With this criteria met, the user will be able to allow the oscilloscope to free run until the units starts again after clear-down with start-up procedure. Then the storage oscilloscope should be stopped so that the preactivation sequence can be reviewed for compliance.</p> <ul style="list-style-type: none"> <li>• Check if an empty MS message was send (zoom into the signal and check the bytes by means of the phase jumps)</li> <li>• Check if the clear-down procedure was done successfully</li> </ul> |
| Expected Results | <p>The STU-R should always answer with an ACK(1) message to finish transaction C (basic transaction C, ITU-T G.994.1 Section 10.1 and 10.1.3) and shall then initiate either Transaction A, Transaction B, or Transaction D during the same session to select a mode (common or no common) of operation identified during the capabilities exchange. Thus following messages are allowed to be sending by a STU-R in response to the CL of the STU-C:</p> <p style="text-align: center;">ACK(1) and MS or<br/>ACK(1) and MR or<br/>ACK(1) and MP.</p> <p>The transaction should end with the clear down procedure</p>                                                                                               |

### 4.3.3 Activation Tests Over Various Test Loops

These tests are designed to execute various test loops without impairments added to the loop. Test Loops for both Annex A and Annex B have been included in the Tests identified in this section.

#### 4.3.3.1 Activation – Test Loops Annex A

**Test Label:** STU-R activation. Annex\_A loops.shdsl

**Purpose:** The purpose of this test is to determine the effects of different Annex A Test Loops on the activation sequence.

**Resource Requirements:**

- STU-R unit
- STU-C unit
- Line Simulators capable of simulating SHDSL Annex A loopset.

**Discussion:** Test for low BER data transfer. To perform this test, STU-R and STU-C units will be connected to opposing ends of a DLS. The DLS shall be configured to the

various Annex A test loops in Figure 8 and as specified in Tables 5 and 6. The test shall be executed without noise inserted into the loop by the DLS. Each DUT should successfully pass through the activation states specified in Figure 6.7 of the ITU-T G.991.2 Recommendation without entering the exception state. Both units should converge and be ready to pass data.

**Procedure:**

- Configure the DLS to simulate the test Loop
- Connect a STU-R and STU-C to opposite ends of the DLS.
- Configure the DSL to provide noise free simulation over specified loop.
- STU-R should not set any limits – STU-C will determine the rates and settings
- Set at the STU-C to the fixed rate to be tested as per Tables 5 and 6 for Annex A
- Test for convergence

|                        |                                                                                                |
|------------------------|------------------------------------------------------------------------------------------------|
| Test Case Identifier   | SH-4331-00                                                                                     |
| Test Case Name         | Activation – Test Loops Annex A                                                                |
| Test Purpose           | Purpose is to determine the effects of different Annex A Test Loops on the activation sequence |
| Standard Requirement   | ITU-T G.991.2 (Section 6.2.2) – per states specified in Figure 6.7                             |
| Additional Information | For test loops in Figure 8, conduct tests specified in Tables 5 and 6.                         |
| Expected Results       | Verify that device reaches convergence                                                         |

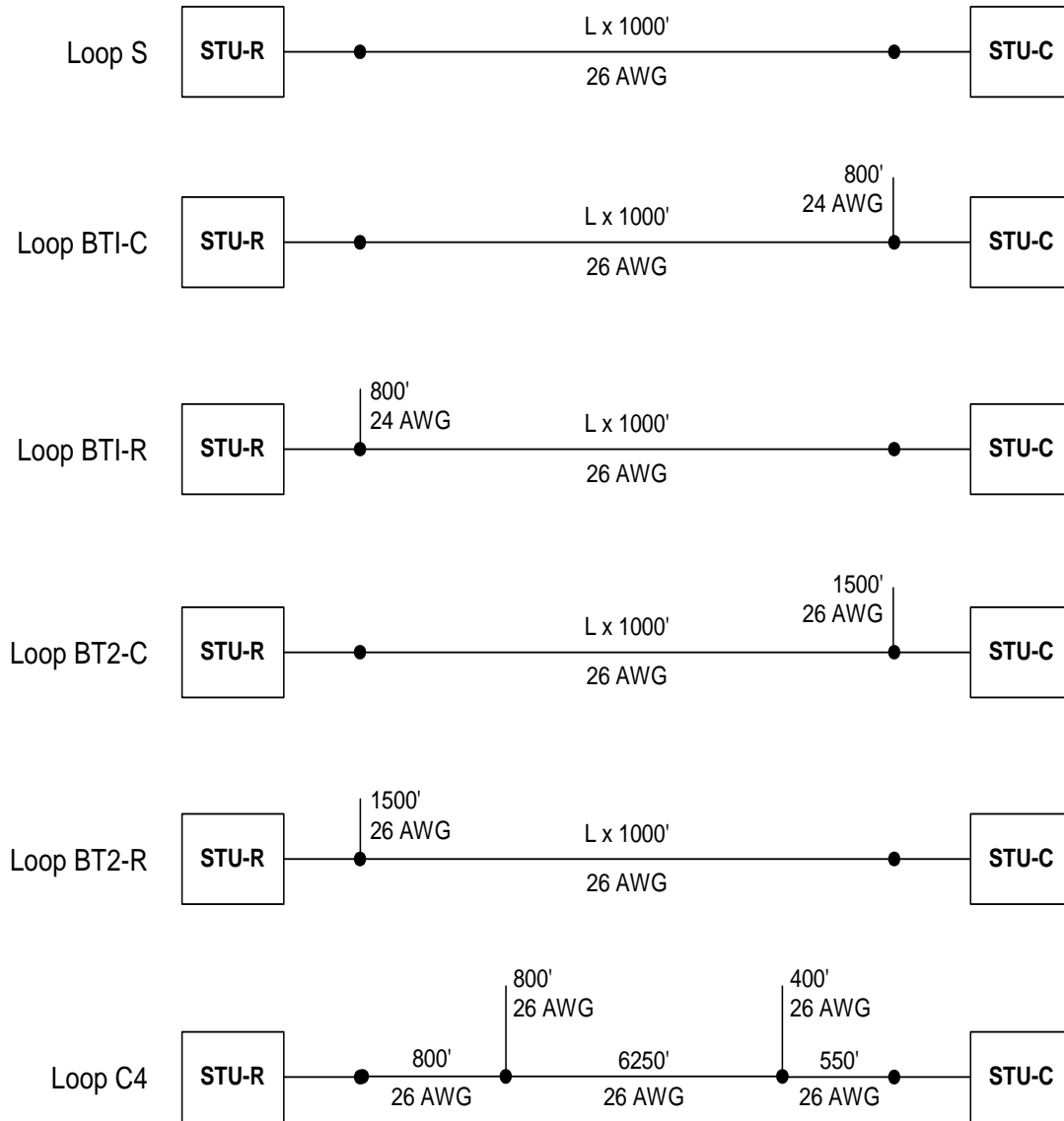

**NOTES:**

AWG = American Wire Gauge; 26 AWG = 0.4 mm, 24 AWG = 0.5 mm  
 Distances in Feet ('): 1000' = 0.3048 km

**Figure 8: Test Loops for Annex A**

TABLE 5: ITU-T G.991.2: ANNEX A – SYMMETRIC RATES

| Test  | Test Loop | L (kft) | Test Unit | Payload Bit Rate (kbps) | Interferer Combination           |
|-------|-----------|---------|-----------|-------------------------|----------------------------------|
| 9     | S         | 6.3     | STU-C     | 2 304                   | 24-T1 + 24 SHDSL asym 1544       |
| 10    | BT1-C     | 5.2     | STU-C     | 2 304                   | 24-T1 + 24 SHDSL asym 1544       |
| 11    | BT1-C     | 5.2     | STU-C     | 2 304                   | 49-SHDSL                         |
| 12    | S         | 6.3     | STU-R     | 2 304                   | 49-SHDSL                         |
| 13    | BT1-R     | 5.2     | STU-R     | 2 304                   | 49-SHDSL                         |
| 14    | BT1-R     | 5.2     | STU-R     | 2 304                   | 24-T1 + 24 SHDSL asym 1544       |
| 15    | S         | 6.8     | STU-C     | 2 048                   | 24-SHDSL + 24-FDD ADSL           |
| 16    | BT1-C     | 5.6     | STU-C     | 2 048                   | 49-SHDSL                         |
| 17    | BT1-C     | 5.6     | STU-C     | 2 048                   | 24-T1 + 24 SHDSL asym 1544       |
| 18    | S         | 6.8     | STU-R     | 2 048                   | 49-SHDSL                         |
| 19    | BT1-R     | 5.6     | STU-R     | 2 048                   | 49-SHDSL                         |
| 20    | BT1-R     | 5.6     | STU-R     | 2 048                   | 24-T1 + 24 SHDSL asym 1544       |
| 21    | S         | 7.9     | STU-C     | 1 544                   | 39-SHDSL asym 1544               |
| 22    | BT1-C     | 6.4     | STU-C     | 1 544                   | 24-FDD ADSL + 24 SHDSL asym 1544 |
| 23    | BT1-C     | 6.4     | STU-C     | 1 544                   | 24-SHDSL + 24-FDD ADSL           |
| 24    | S         | 7.9     | STU-R     | 1 544                   | 49-SHDSL                         |
| 25    | BT1-R     | 6.4     | STU-R     | 1 544                   | 24-T1 + 24 SHDSL asym 1544       |
| 26    | BT1-R     | 6.4     | STU-R     | 1 544                   | 49-SHDSL                         |
| 27/30 | S         | 11.0    | STU-C/R   | 768                     | 49-HDSL                          |
| 28/31 | BT1-C     | 10.2    | STU-C/R   | 768                     | 49-SHDSL                         |
| 29/32 | BT1-C     | 10.2    | STU-C/R   | 768                     | 49-HDSL                          |
| 39/42 | S         | 14.8    | STU-C/R   | 384                     | 24-SHDSL + 24-DSL                |
| 40/43 | BT2-C     | 13.8    | STU-C/R   | 384                     | 24-SHDSL + 24-DSL                |
| 41/44 | BT2-C     | 13.8    | STU-C/R   | 384                     | 49-SHDSL                         |
| 45/48 | S         | 17.2    | STU-C/R   | 256                     | 49-DSL                           |
| 46/49 | BT2-C     | 16.4    | STU-C/R   | 256                     | 49-DSL                           |
| 47/50 | BT2-C     | 16.4    | STU-C/R   | 256                     | 24-SHDSL + 24-DSL                |
| 51/54 | S         | 19.8    | STU-C/R   | 192                     | 49-DSL                           |
| 52/55 | BT2-C     | 19.1    | STU-C/R   | 192                     | 49-DSL                           |
| 53/56 | BT2-C     | 19.1    | STU-C/R   | 192                     | 24-DSL + 24 SHDSL                |

TABLE 6: ITU-T G.991.2: ANNEX A – ASYMMETRIC RATES

| Test  | Test Loop | L (kft) | Test Unit | Payload Bit Rate (kbps) | Interferer Combination |
|-------|-----------|---------|-----------|-------------------------|------------------------|
| 1 / 7 | C4        | -       | STU-C /R  | 1544                    | 24T1 + 24 SHDSL        |
| 2     | C4        | -       | STU-C     | 1544                    | 39 SHDSL               |
| 3     | C4        | -       | STU-C     | 1544                    | 24 FDD ADSL + 24 HDSL  |
| 4 / 8 | S         | 9.0     | STU-C/ R  | 1544                    | 24T1 + 24 SHDSL        |
| 5     | S         | 9.0     | STU-C     | 1544                    | 39 SHDSL               |
| 6     | S         | 9.0     | STU-C     | 1544                    | 24 FDD ADSL + 24 HDSL  |
| 33    | S         | 11.2    | STU-C     | 768                     | 49-HDSL                |
| 34    | BT1-C     | 10.4    | STU-C     | 768                     | 49-HDSL                |
| 35    | BT1-C     | 10.4    | STU-C     | 768                     | 24-FDD ADSL+24-HDSL    |
| 36    | S         | 11.2    | STU-R     | 768                     | 24-T1+24 HDSL          |
| 37    | BT1-R     | 10.4    | STU-R     | 768                     | 24-T1+24-SHDSL         |
| 38    | BT1-R     | 10.4    | STU-R     | 768                     | 39-FDD ADSL            |

#### 4.3.3.2 Activation – Test Loops Annex B

**Test Label:** STU-R activation. Annex\_B loops.shdsl

**Purpose:** The purpose of this test is to determine the effects of different Annex B Test Loops on the activation sequence.

**Resource Requirements:**

- STU-R unit
- STU-C unit
- Line Simulators capable of simulating SHDSL Annex B loopset.

**Discussion:** Test for error-free data transfer. To perform this test, STU-R and STU-C units will be connected to opposing ends of a DLS. The DLS shall be configured to the various Annex B test loops in Figure 9 and as specified in Tables 7-10. The test shall be executed without noise inserted into the loop by the DLS. Each DUT should successfully pass through the activation states specified in Fig 6.7 of the ITU-T G.991.2 Recommendation without entering the exception state. Both units should converge and be ready to pass data.

Note: DLS global change

**Procedure:**

- Configure the DLS to simulate the test Loop

- Connect a STU-R and STU-C to opposite ends of the DLS.
- Configure the DSL to provide noise free simulation over specified loop.
- STU-R should not set any limits – STU-C will determine the rates and settings
- Set at the STU-C to the fixed rate to be tested as per Table 7-10 for Annex B
- Test for convergence

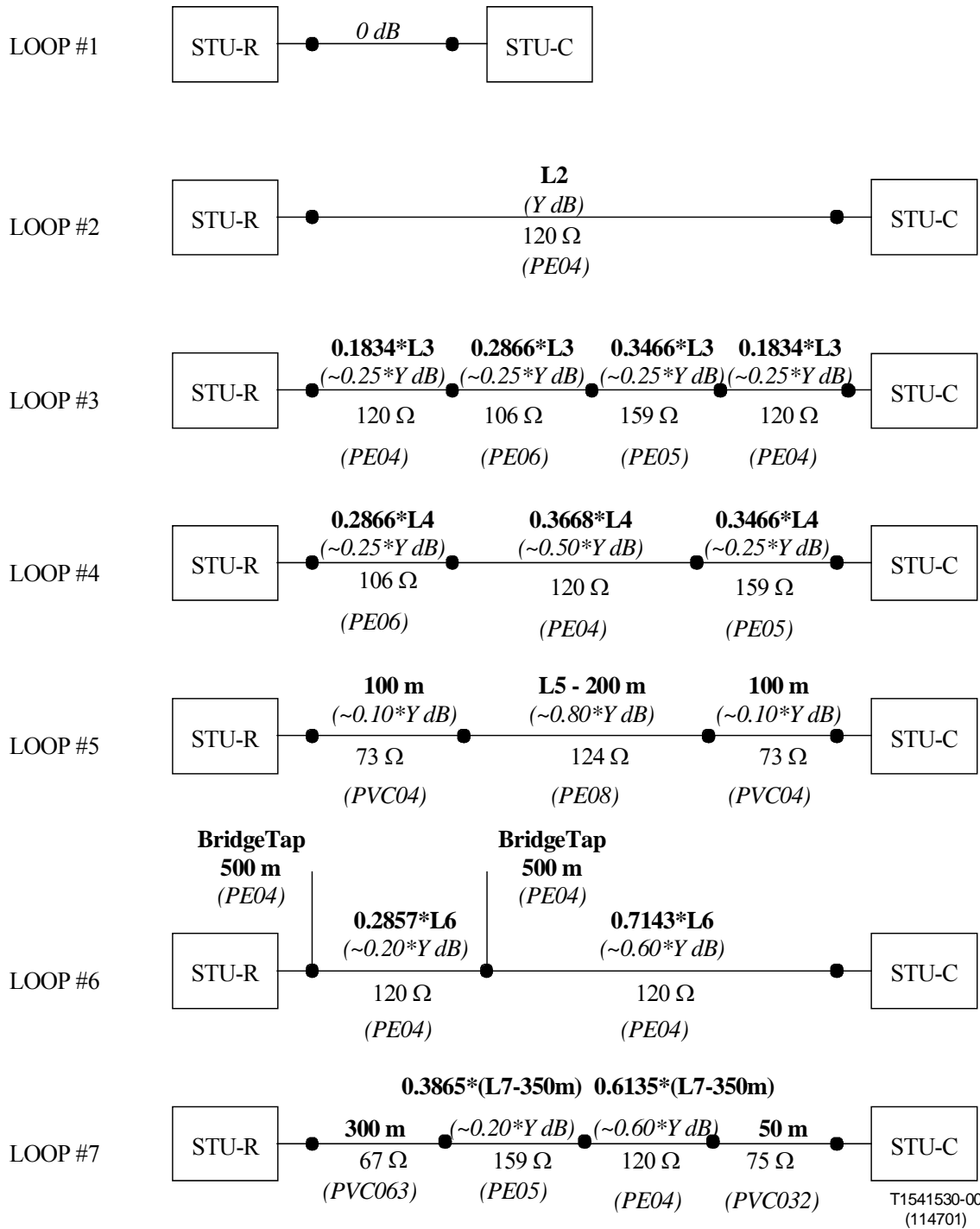

NOTE 1 - The values for  $Y$  and  $L$  are to be found in Table B-1.

NOTE 2 - Due to mismatches and bridged taps the total attenuation of the test loops differs from the sum of the attenuation of the parts.

NOTE 3 - The impedances are for information only. They refer to the characteristic impedances of the test cables as defined in Appendix II measured at 300 kHz.

**Figure 9: ITU-T G.991.2: Annex B; ETSI TS101 524: Section 12.3**

TABLE 7: STU-C- ITU-T G.991.2: ANNEX B; ETSI TS101 524: SECTION 12.3 – SYMMETRIC PSDS

| Test   | Test Loop | <i>Y</i> (dB) | Test Unit | Payload Bit Rate (kbps) | Interferer Combination |
|--------|-----------|---------------|-----------|-------------------------|------------------------|
| 57     | 2         | 43.0 @150kHz  | STU-C     | 384                     | Noise Model A          |
| 58     | 2         | 37.0 @150kHz  | STU-C     | 512                     | Noise Model A          |
| 59     | 2         | 29.0 @150kHz  | STU-C     | 768                     | Noise Model A          |
| 60     | 2         | 35.5 @150kHz  | STU-C     | 1024                    | Noise Model A          |
| 61     | 2         | 22.0 @150kHz  | STU-C     | 1280                    | Noise Model A          |
| 62     | 2         | 19.0 @150kHz  | STU-C     | 1536                    | Noise Model A          |
| 63     | 2         | 17.5 @200kHz  | STU-C     | 2048                    | Noise Model A          |
| 64     | 2         | 15.5 @200kHz  | STU-C     | 2304                    | Noise Model A          |
| 67     | 5         | 50.0 @150kHz  | STU-C     | 384                     | Noise Model B          |
| 68     | 5         | 24.0 @200kHz  | STU-C     | 2048                    | Noise Model B          |
| 69     | 5         | 21.5 @200kHz  | STU-C     | 2304                    | Noise Model B          |
| 72     | 2         | 50.0 @150kHz  | STU-C     | 384                     | Noise Model C          |
| 73     | 2         | 44.0 @150kHz  | STU-C     | 512                     | Noise Model C          |
| 74     | 2         | 35.5 @150kHz  | STU-C     | 768                     | Noise Model C          |
| 75     | 2         | 32.0 @150kHz  | STU-C     | 1024                    | Noise Model C          |
| 76     | 2         | 28.5 @150kHz  | STU-C     | 1280                    | Noise Model C          |
| 77     | 2         | 25.5 @150kHz  | STU-C     | 1536                    | Noise Model C          |
| 78     | 2         | 24.0 @200kHz  | STU-C     | 2048                    | Noise Model C          |
| 79     | 2         | 21.5 @200kHz  | STU-C     | 2304                    | Noise Model C          |
| 82/ 83 | 2, 3      | 50.0 @150kHz  | STU-C     | 384                     | Noise Model D          |
| 84     | 2         | 44.0 @150kHz  | STU-C     | 512                     | Noise Model D          |
| 85     | 2         | 35.5 @150kHz  | STU-C     | 768                     | Noise Model D          |
| 86     | 2         | 32.0 @150kHz  | STU-C     | 1024                    | Noise Model D          |
| 87     | 2         | 28.5 @150kHz  | STU-C     | 1280                    | Noise Model D          |
| 88     | 2         | 25.5 @150kHz  | STU-C     | 1536                    | Noise Model D          |
| 89     | 2         | 24.0 @200kHz  | STU-C     | 2048                    | Noise Model D          |
| 90/ 91 | 2, 3      | 21.5 @200kHz  | STU-C     | 2304                    | Noise Model D          |

|                      |                                                                                                                                      |
|----------------------|--------------------------------------------------------------------------------------------------------------------------------------|
| Test Case Identifier | SH-4332-00                                                                                                                           |
| Test Case Name       | Activation – Test Loops Annex B                                                                                                      |
| Test Purpose         | The purpose of this test is to determine the effects of different Annex B Test Loops on the activation sequence                      |
| Standard Requirement | ITU-T G.991.2 (Section 6.2.2) The purpose of this test is to determine the effects of different Annex B Test Loops on the activation |



|                        |                                                                                                                         |
|------------------------|-------------------------------------------------------------------------------------------------------------------------|
|                        | sequence: □ ETSI TS 101 524: Section 12.3 ?                                                                             |
| Additional Information | <ul style="list-style-type: none"> <li>For test loops in Figure 8, conduct tests specified in Tables 7 - 10.</li> </ul> |
| Expected Results       | Verify that device reaches convergence                                                                                  |

TABLE 8: STU-C- ITU-T G.991.2: ANNEX B; ETSI TS 101 524: SECTION 12.3 – ASYMMETRIC PSDS

| Test   | Test Loop | <i>Y</i> (dB) | Test Unit | Payload Bit Rate (kbps) | Interferer Combination |
|--------|-----------|---------------|-----------|-------------------------|------------------------|
| 65     | 2         | 17.5 @200kHz  | STU-C     | 2048                    | Noise Model A          |
| 66     | 2         | 15.5 @200kHz  | STU-C     | 2304                    | Noise Model A          |
| 70     | 5         | 24.0 @200kHz  | STU-C     | 2048                    | Noise Model B          |
| 71     | 5         | 21.5 @200kHz  | STU-C     | 2304                    | Noise Model B          |
| 80     | 2         | 24.0 @200kHz  | STU-C     | 2048                    | Noise Model C          |
| 81     | 2         | 21.5 @200kHz  | STU-C     | 2304                    | Noise Model C          |
| 92/ 93 | 2, 3      | 24.0 @200kHz  | STU-C     | 2048                    | Noise Model D          |
| 94/ 95 | 2, 3      | 21.5 @200kHz  | STU-C     | 2304                    | Noise Model D          |

TABLE 9: STU-R- ITU-T G.991.2: ANNEX B; ETSI TS 101 524: SECTION 12.3 – SYMMETRIC PSDS

| Test          | Test Loop | <i>Y</i> (dB) | Test Unit | Payload Bit Rate (kbps) | Interferer Combination |
|---------------|-----------|---------------|-----------|-------------------------|------------------------|
| 96 / 97/ 98   | 4, 6, 7   | 43.0 @150kHz  | STU-R     | 384                     | Noise Model A          |
| 99/ 100/ 101  | 4, 6, 7   | 17.5 @200kHz  | STU-R     | 2048                    | Noise Model A          |
| 102/ 103/ 104 | 4, 6, 7   | 15.5 @200kHz  | STU-R     | 2304                    | Noise Model A          |
| 111           | 7         | 50.0 @150kHz  | STU-R     | 384                     | Noise Model B          |
| 112           | 7         | 24.0 @200kHz  | STU-R     | 2048                    | Noise Model B          |
| 113           | 7         | 21.5 @200kHz  | STU-R     | 2304                    | Noise Model B          |
| 116/ 117/ 118 | 4, 6, 7   | 50.0 @150kHz  | STU-R     | 384                     | Noise Model C          |
| 119/ 120/ 121 | 4, 6, 7   | 24.0 @200kHz  | STU-R     | 2048                    | Noise Model C          |
| 122/ 123/ 124 | 4, 6, 7   | 21.5 @200kHz  | STU-R     | 2304                    | Noise Model C          |
| 131           | 7         | 50.0 @150kHz  | STU-R     | 384                     | Noise Model D          |
| 132           | 7         | 24.0 @200kHz  | STU-R     | 2048                    | Noise Model D          |
| 133           | 7         | 21.5 @200kHz  | STU-R     | 2304                    | Noise Model D          |

TABLE 10: STU-R- ITU-T G.991.2: ANNEX B; ETSI TS101 524: SECTION 12.3 – ASYMMETRIC PSDS

| Test          | Test Loop | $Y$ (dB)     | Test Unit | Payload Bit Rate (kbps) | Interferer Combination |
|---------------|-----------|--------------|-----------|-------------------------|------------------------|
| 105/ 106/ 107 | 4, 6, 7   | 17.5 @200kHz | STU-R     | 2048                    | Noise Model A          |
| 108/ 109/ 110 | 4, 6, 7   | 15.5 @200kHz | STU-R     | 2304                    | Noise Model A          |
| 114           | 7         | 24.0 @200kHz | STU-R     | 2048                    | Noise Model B          |
| 115           | 7         | 21.5 @200kHz | STU-R     | 2304                    | Noise Model B          |
| 125/ 126/ 127 | 4, 6, 7   | 24.0 @200kHz | STU-R     | 2048                    | Noise Model C          |
| 128/ 129/ 130 | 4, 6, 7   | 21.5 @200kHz | STU-R     | 2304                    | Noise Model C          |
| 134           | 7         | 24.0 @200kHz | STU-R     | 2048                    | Noise Model D          |
| 135           | 7         | 21.5 @200kHz | STU-R     | 2304                    | Noise Model D          |

## 4.4 Noise Performance

### 4.4.1 Test Configuration

STU-R and STU-C are connected at both side of the SHDSL line simulator as depicted by the Figure 10 below.

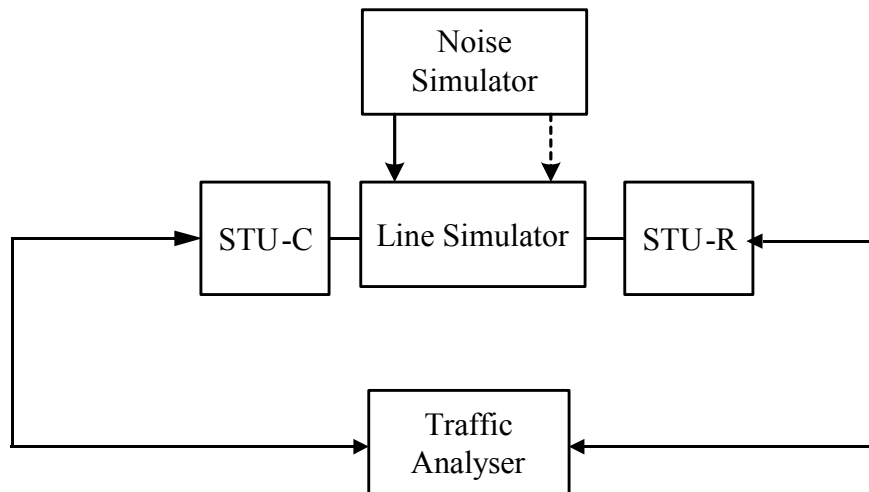

Figure 10 – Noise Test Setup

The noise (specified by the test reference in 4.4.3) is injected only at one side at a time. The devices are in normal operational mode. .

#### 4.4.2 Test Procedure

- STU-R should not set any limits – STU-C will determine the rates and settings
- Set the STU-C to the fixed rate to be tested as per Tables 5 – 10 as appropriate
- Set the noise required. For annex A, the modems are trained with a noise level corresponding to 0 dB plus the required margin. The 0 dB level PSD is defined in section G.991.2 section A.3.3. For annex B and TS 101 524, the modems are trained with a noise level corresponding to 0dB margin. The 0dB level is defined in TS 101 524 annex I.
- Connect modems with SHDSL loops as per Tables 5 - 10, and wait for synchronization. For annex B and TS 101 524, the noise level is then increased by the required margin.
- Wait a minimum of 5 minutes for settling before the BER test is started.
- Send a minimum  $10^9$  bits with at least a  $2^{15}-1$  random pattern
- Record the bit error average.
- If the bit error average is less then or equal to  $10^{-7}$ , decrease the noise mask level by 1dB and repeat the previous steps.

The measured margin is then equal to the required margin minus the number of dBs the noise was decreased until a bit error average less than or equal to  $10^{-7}$  was measured.

#### 4.4.3 Expected Result

ITU-T G.991.2

**Annex A:** The system should be able to sustain a minimum of 5dB -  $\Delta$  of margin with  $< \sim 1e-7$  bit error. Where  $\Delta$  is 1.25 for equipment loss, when calibration is not applied.

**Annex B:** ETSI TS101 524: Section 12.3: The system should be able to sustain a minimum of 6dB -  $\Delta$  of margin with  $< \sim 1e-7$  bit error. Where  $\Delta$  is 1.25 for equipment loss.

#### Noise PSD Calibration

##### Annex A

To compensate for the change in line impedance at low frequencies, the G.991.2 specification defines specific test cases where the noise PSD may be adjusted to compensate for the impedance mismatch. If the noise margin recorded does not meet the requirements of the specific Annex, perform a noise calibration per G.991.2 and repeat the noise testing steps.

|                      |                                                                     |
|----------------------|---------------------------------------------------------------------|
| Test Case Identifier | SH-4430-01                                                          |
| Test Case Name       | Noise Performance - Annex A                                         |
| Test Purpose         | Purpose is to determine the effects of different Annex A Test Loops |
| Standard Requirement | ITU-T G.991.2 (Section A.3.3)                                       |

|                        |                                                                                                                                                                                                                                                                                                                                                                                                                                                                                                                                                                                                                                                                                                                                  |
|------------------------|----------------------------------------------------------------------------------------------------------------------------------------------------------------------------------------------------------------------------------------------------------------------------------------------------------------------------------------------------------------------------------------------------------------------------------------------------------------------------------------------------------------------------------------------------------------------------------------------------------------------------------------------------------------------------------------------------------------------------------|
| Additional Information | <p>For test loops in Figure 8, conduct tests specified in Tables 5 and 6.</p> <ul style="list-style-type: none"> <li>• Set the noise required. For annex A, the modems are trained with a noise level corresponding to 0 dB plus the required margin.</li> <li>• Connect modems and wait for synchronization. Wait a minimum of 5 minutes for settling before the BER test is started.</li> <li>• Send a minimum <math>10^9</math> bits with at least a <math>2^{15}-1</math> random pattern</li> <li>• Record the bit error average.</li> <li>• If the bit error average is worse than <math>10^{-7}</math> (i.e. <math>BER &gt; 10^{-7}</math>) decrease the noise mask level by 1dB and repeat the previous steps.</li> </ul> |
| Expected Results       | System should be able to sustain a minimum of 5dB - $\Delta$ of margin with $< \sim 1e-7$ bit error                                                                                                                                                                                                                                                                                                                                                                                                                                                                                                                                                                                                                              |

### TS 101 524 and Annex B

The latest revision of TS 101 524 (2002-11) contains new test for a noise calibration procedure, a noise substitution rule to reduce the number of noise shapes used and a modification of the white noise levels. The test was adopted for G.shdsl.bis in January 2003 however the specification has not been published yet. For the purpose of this specification, the procedure described in TS 101 524 shall be used for both TS 101 524 and G.shdsl Annex B testing.

To compensate for the change in line impedance at low frequencies, the noise calibration procedure of TS 101 524 (2002-11) section 12.2.3 shall be used. Annex I lists in tabular form, the expected noise values as a function of frequency. Section 12.5.3.4 lists the requirements for the white noise generator while section 12.5.4.3 describes a mandatory noise substitution rule. The rest of the testing procedure is identical in G.991.2 and TS 101 524.

|                        |                                                                                                                                                                                                                                                                                                                                                                                                                                                                                                                                             |
|------------------------|---------------------------------------------------------------------------------------------------------------------------------------------------------------------------------------------------------------------------------------------------------------------------------------------------------------------------------------------------------------------------------------------------------------------------------------------------------------------------------------------------------------------------------------------|
| Test Case Identifier   | SH-4430-02                                                                                                                                                                                                                                                                                                                                                                                                                                                                                                                                  |
| Test Case Name         | Noise Performance Annex B                                                                                                                                                                                                                                                                                                                                                                                                                                                                                                                   |
| Test Purpose           | Determine the effects of different Annex B Test Loops                                                                                                                                                                                                                                                                                                                                                                                                                                                                                       |
| Standard Requirement   | ETSI TS 101 524 annex I                                                                                                                                                                                                                                                                                                                                                                                                                                                                                                                     |
| Additional Information | <p>For test loops in Figure 9, conduct tests specified.</p> <ul style="list-style-type: none"> <li>• Set the noise required</li> <li>• Connect modems with SHDSL loops in Tables 7 – 10 and wait a minimum of 5 minutes for settling before the BER test is started.</li> <li>• Send a minimum <math>10^9</math> bits with at least a <math>2^{15}-1</math> random pattern</li> <li>• Record the bit error average.</li> <li>• If the bit error average is worse than <math>10^{-7}</math>, (i.e. <math>BER &gt; 10^{-7}</math>)</li> </ul> |

|                  |                                                                                                      |
|------------------|------------------------------------------------------------------------------------------------------|
|                  | decrease the noise mask level by 1dB and repeat the previous steps.                                  |
| Expected Results | System should be able to sustain a minimum of 6dB - $\Delta$ of margin with $< \sim 1e-7$ bit error. |

#### 4.5 Line Probe Testing (Rate Adaptive Mode Testing)

For all adaptive rate optional tests, set the STU-R to rate adaptive if applicable.

|                        |                                                                                                                                                                                                                                                                                                              |
|------------------------|--------------------------------------------------------------------------------------------------------------------------------------------------------------------------------------------------------------------------------------------------------------------------------------------------------------|
| Test Case Identifier   | SH-4500-00                                                                                                                                                                                                                                                                                                   |
| Test Case Name         | Error-Free Data Transfer; Rate Adaptive performance Current Margin, optional if supported.                                                                                                                                                                                                                   |
| Test Purpose           | This test verifies that two systems do achieve steady transmission state when they are linked to each other over a set of test loops with noise applied and when running Rate Adaptive. It should also prove that the Minimum rate required for performance can be achieved, and the required margin is met. |
| Standard Requirement   | <ul style="list-style-type: none"> <li>• ITU-T G.991.2: (Section 6.3, A.5.6, B.5.6)</li> <li>• ETSI TS 101 524: (Section 12.3)</li> </ul>                                                                                                                                                                    |
| Additional Information | The following tests loops are to be used in the course of this test: see Table 11.                                                                                                                                                                                                                           |
| Expected Results       | Selected rate should be greater than or equal the minimum line rates listed in Table 11.<br>The complete test case is passed if 6 of 7 Annex A test steps and 7 of 8 Annex B test steps are passed.                                                                                                          |

##### 4.5.1 Test Configuration

STU-R and STU-C are connected at both sides of the SHDSL line simulator as depicted by Figure 1.

##### 4.5.2 Method of Procedure

- STU-R should not set any limits – STU-C will determine the settings
- Set at the STU-C to the Rate Adaptive
- Define line probe sequence as per G.991.2 Section 6.3.2 and illustrated in Figure 6-9/G.991.2 – “Typical timing diagram for pre-activation sequence”, and code points as defined in G.991.2 Section 6.4.1
- Set the Current Condition Target Margin to 5dB for Annex A tests and to 6 dB for Annex B tests as shown in Table 11.

- Disable the Worst Case Target Margin
- Set the noise simulator to apply 49-SHDSL NEXT @ 2304 kbps, 0 dB where the NEXT used is based on Annex A or Annex B as specified in Table 11. For Annex A, this noise is equal to noise of test case 11 in G.991.2, Table A-1. For Annex B, this noise is equal to the pure self-crosstalk scenario of noise model D @ 2304 kbps, 0 dB, in G.991.2.
- Connect modems over the loop type and length specified in Table 11 below, set the appropriate Annex type for the connection, wait for synchronization
- Increase the noise level with 5dB for Annex A and 6 dB for Annex B tests.
- Wait a minimum of 5 minutes for settling before starting the BER test is started as per G.991.2 A.3.1.5
- Send a minimum  $10^8$  bits with at least a  $2^{15}-1$  random pattern
- If the bit error rate is less than  $10^{-7}$ , record the rate achieved
- The complete test case is passed if 6 of 7 Annex A test steps and 7 of 8 Annex B test steps are passed.

#### 4.5.3 Expected Result

The Line rates in Table 11 are the minimum rates required for the given loop type.

TABLE 11: RATE ADAPTIVE LOOPS

| Annex Type | Loop Type | Loop Length | Noise Model        | Target Margin | Minimum Line Rate |
|------------|-----------|-------------|--------------------|---------------|-------------------|
| A          | 26AWG (S) | 19.3 kft    | 49-SHDSL, 2304kbps | 5 dB          | 200               |
| A          | 26AWG (S) | 16.7 kft    | 49-SHDSL, 2304kbps | 5 dB          | 264               |
| A          | 26AWG (S) | 14.3 kft    | 49-SHDSL, 2304kbps | 5 dB          | 392               |
| A          | 26AWG (S) | 10.6 kft    | 49-SHDSL, 2304kbps | 5 dB          | 776               |
| A          | 26AWG (S) | 7.6 kft     | 49-SHDSL, 2304kbps | 5 dB          | 1544              |
| A          | 26AWG (S) | 6.5 kft     | 49-SHDSL, 2304kbps | 5 dB          | 2056              |
| A          | 26AWG (S) | 6.1 kft     | 49-SHDSL, 2304kbps | 5 dB          | 2312              |
| B          | PE04 (L2) | 4.5 km      | Model D, 2304kbps  | 6 dB          | 392               |
| B          | PE04 (L2) | 4.0 km      | Model D, 2304kbps  | 6 dB          | 520               |
| B          | PE04 (L2) | 3.2 km      | Model D, 2304kbps  | 6 dB          | 776               |
| B          | PE04 (L2) | 2.9 km      | Model D, 2304kbps  | 6 dB          | 1032              |
| B          | PE04 (L2) | 2.6 km      | Model D, 2304kbps  | 6 dB          | 1288              |
| B          | PE04 (L2) | 2.3 km      | Model D, 2304kbps  | 6 dB          | 1544              |
| B          | PE04 (L2) | 2.0 km      | Model D, 2304kbps  | 6 dB          | 2056              |
| B          | PE04 (L2) | 1.8 km      | Model D, 2304kbps  | 6 dB          | 2312              |

Note:

The loop lengths chosen in Table 11 are slightly smaller (about 3%) than the loop lengths according to the appropriate noise performance tests in G.991.2 in order to allow a small tolerance for the rate decision process.

The loop lengths for Annex A tests are derived from the straight-loop test cases (26AWG Loop S) in G.991.2, Table A-1.

The loop lengths for Annex B tests are derived from straight-loop test cases (PE04 L2), Noise Model D, in G.991.2, Table B-2.

#### 4.5.4 Test Configuration

STU-R and STU-C are connected at both sides of the SHDSL line simulator as depicted by Figure 1.

|                        |                                                                                                                                                                                                                                                         |
|------------------------|---------------------------------------------------------------------------------------------------------------------------------------------------------------------------------------------------------------------------------------------------------|
| Test Case Identifier   | SH-4540-00                                                                                                                                                                                                                                              |
| Test Case Name         | Functional Test; Rate Adaptive, Worst Case Margin, optional if supported.                                                                                                                                                                               |
| Test Purpose           | This test verifies that two systems do achieve steady transmission state when they are linked to each other over a set of test loops and when running Rate Adaptive Worst Case Margin. This would prove that the worst case margin would be functional. |
| Standard Requirement   | <ul style="list-style-type: none"> <li>• ITU-T G.991.2 (Sections 6.3 and 6.4)</li> <li>• ETSI TS 101 524: Section 12.3</li> </ul>                                                                                                                       |
| Additional Information | The following tests loops are to be used in the course of this test: see Table 12.                                                                                                                                                                      |
| Expected Results       | <p>Selected rate should be within the minimum and maximum line rates listed in Table 12.</p> <p>The complete test case is passed if 6 of 7 Annex A test steps and 7 of 8 Annex B test steps are passed.</p>                                             |

#### 4.5.5 Method of Procedure

- STU-R should not set any limits – STU-C will determine the settings
- Set at the STU-C to the Rate Adaptive
- Define line probe sequence as per G.991.2 Section 6.3.2 and illustrated in Figure 6-9/G.991.2 – “Typical timing diagram for pre-activation sequence”, and code points as defined in G.991.2 Section 6.4.1
- Disable the Current Condition Margin
- Set the Worst Case Margin to 5dB for Annex A tests and to 6 dB for the Annex B tests as shown in Table 12.
- Set the noise simulator to apply white noise at -140 dBm/Hz.  
 Note: This means that almost noise free environment is used for these tests. This is due to the fact that the test should verify if the rate is selected according to pre-measured reference worst case noise instead of current condition noise on the line. Worst case reference noises for PMMS are defined in ITU-T G.991.2, A.5.6 and Table A-13 for Annex A, and B.5.6 and Table B-14 for Annex B. Worst case noise is 49-SHDSL NEXT disturbers for both, Annex A and Annex B.
- Connect modems over the loop type and length specified in Table 12 below, set the appropriate Annex type for the connection, wait for synchronization

- Wait a minimum of 5 minutes for settling before starting the BER test.
- Send a minimum  $10^8$  bits with at least a  $2^{15}-1$  random pattern
- If the bit error rate is less than  $10^{-7}$ , record the rate achieved
- A test step is passed if the achieved rate is greater than or equal the minimum line rate of Table 12 and if it is smaller than or equal to the maximum line rate of Table 12.
- The complete test case is passed if 6 of the 7 annex A test steps and 7 of the 8 annex B test steps are passed.

#### 4.5.6 Expected Result

The minimum line rates in the Table 12 below are the minimum rates PMMS has to select for the given input parameters, annex type, loop type, loop length, noise model, noise level, and target margin. They are determined by calculations based on the following parameters: 2.5dB implementation loss, 5.1dB coding gain, 7dB (annex A) or 8dB (annex B) operating margin, 49 NEXT disturbers.

The maximum line rates in Table 12 are the maximum rates PMMS has to select for the given input parameters, annex type, loop type, loop length, noise model, noise level, and target margin. These maximum rates represent a theoretical upper limit for the achievable rate in the presence of 49 NEXT disturbers. They are determined by calculations based on the following parameters: 0dB implementation loss, 5.1dB coding gain, 5dB (annex A) or 6dB (annex B) operating margin, 49 NEXT disturbers.



TABLE 12: RATE ADAPTIVE LOOPS WORST CASE

| Annex Type | Loop Type | Loop Length | White Noise | Target Margin | Minimum Line Rate | Maximum Line Rate |
|------------|-----------|-------------|-------------|---------------|-------------------|-------------------|
| A          | AWG26 (S) | 17.2 kft    | -140 dBm/Hz | 5 dB          | 200               | 328               |
| A          | AWG26 (S) | 15.0 kft    | -140 dBm/Hz | 5 dB          | 264               | 456               |
| A          | AWG26 (S) | 13.2 kft    | -140 dBm/Hz | 5 dB          | 392               | 584               |
| A          | AWG26 (S) | 10.2 kft    | -140 dBm/Hz | 5 dB          | 776               | 1032              |
| A          | AWG26 (S) | 7.4 kft     | -140 dBm/Hz | 5 dB          | 1352              | 1992              |
| A          | AWG26 (S) | 6.5 kft     | -140 dBm/Hz | 5 dB          | 1736              | 2312              |
| A          | AWG26 (S) | 6.1 kft     | -140 dBm/Hz | 5 dB          | 1992              | 2312              |
| B          | PE04 (L2) | 4.3 km      | -140 dBm/Hz | 6 dB          | 392               | 584               |
| B          | PE04 (L2) | 3.8 km      | -140 dBm/Hz | 6 dB          | 520               | 776               |
| B          | PE04 (L2) | 3.1 km      | -140 dBm/Hz | 6 dB          | 840               | 1224              |
| B          | PE04 (L2) | 2.8 km      | -140 dBm/Hz | 6 dB          | 1032              | 1544              |
| B          | PE04 (L2) | 2.5 km      | -140 dBm/Hz | 6 dB          | 1288              | 1864              |
| B          | PE04 (L2) | 2.3 km      | -140 dBm/Hz | 6 dB          | 1544              | 2112              |
| B          | PE04 (L2) | 2.0 km      | -140 dBm/Hz | 6 dB          | 1992              | 2312              |
| B          | PE04 (L2) | 1.8 km      | -140 dBm/Hz | 6 dB          | 2248              | 2312              |

**4.6 PMMS (Probe Testing) Compliance Tests**

Line probing is optional. If supported, the following tests apply.

**Test Setup:** STU-R and STU-C are connected at both sides of the SHDSL line simulator as depicted in Figure 11. The storage oscilloscope is used to record the pre-activation sequence.

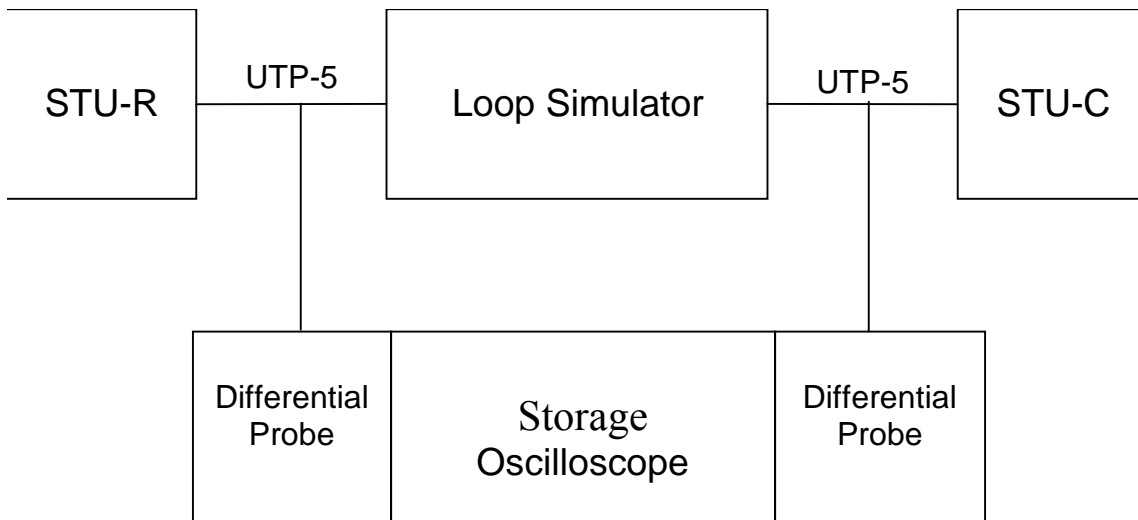
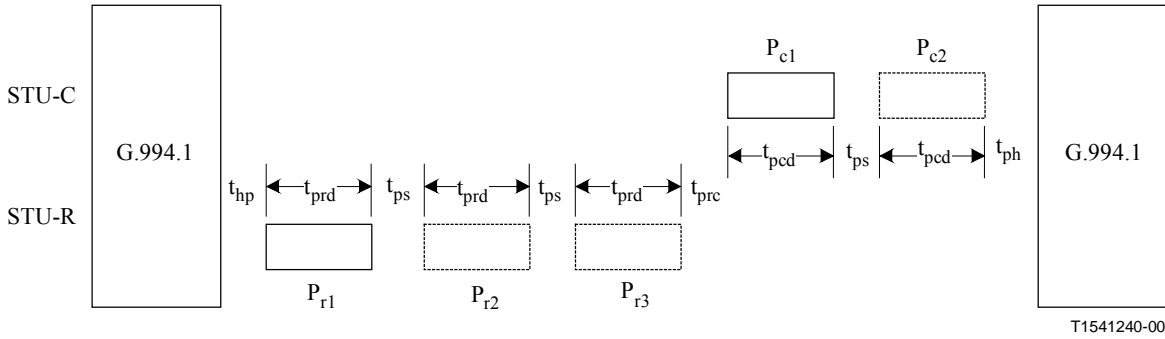

**Figure 11: Set-up to check PMMS timing and signals****4.6.1 PMMS Timing compliance test**

|                        |                                                                                                                                                                                                                                                                                                                                                                                                                                                                                                                                                                                                                                                                                                                                                                                                                                                                                                                                                                                                                                                                                                                 |
|------------------------|-----------------------------------------------------------------------------------------------------------------------------------------------------------------------------------------------------------------------------------------------------------------------------------------------------------------------------------------------------------------------------------------------------------------------------------------------------------------------------------------------------------------------------------------------------------------------------------------------------------------------------------------------------------------------------------------------------------------------------------------------------------------------------------------------------------------------------------------------------------------------------------------------------------------------------------------------------------------------------------------------------------------------------------------------------------------------------------------------------------------|
| Test Case Identifier   | SH-4610-00                                                                                                                                                                                                                                                                                                                                                                                                                                                                                                                                                                                                                                                                                                                                                                                                                                                                                                                                                                                                                                                                                                      |
| Test Case Name         | PMMS Timing Compliance                                                                                                                                                                                                                                                                                                                                                                                                                                                                                                                                                                                                                                                                                                                                                                                                                                                                                                                                                                                                                                                                                          |
| Test Purpose           | This test case is to verify that the PMMS signal timing is within the specified tolerances. Optional if supported                                                                                                                                                                                                                                                                                                                                                                                                                                                                                                                                                                                                                                                                                                                                                                                                                                                                                                                                                                                               |
| Standard Requirement   | ITU-T G.991.2, Section 6.3 ITU-T G.994.1 Annex B                                                                                                                                                                                                                                                                                                                                                                                                                                                                                                                                                                                                                                                                                                                                                                                                                                                                                                                                                                                                                                                                |
| Additional Information | <ul style="list-style-type: none"> <li>Set STU-C and STU-R to use PMMS (Line Probing, Rate Adaptive)</li> </ul>                                                                                                                                                                                                                                                                                                                                                                                                                                                                                                                                                                                                                                                                                                                                                                                                                                                                                                                                                                                                 |
| Procedure              | <ul style="list-style-type: none"> <li>Connect modems with 1000m straight PE04 loop with the noise turned off.</li> <li>Specify the probe settings requested by each of the STUs.</li> <li>Start preactivation.</li> <li>The oscilloscope setup for this test will vary depending upon the make and model. However, an appropriate sweep time and sampling rate should be used to ensure that the entire preactivation sequence of up to 15 seconds is stored. With this criteria met, the user will be able to allow the oscilloscope to free run until the units start the second handshake session. Then the storage oscilloscope should be stopped so that the preactivation sequence can be reviewed for compliance from end of 1<sup>st</sup> handshake to start of 2<sup>nd</sup> handshake.<br/>The preactivation times can be verified through the use of the measurement functions of the oscilloscope.</li> <li>Measure the times <math>t_{hp}</math>, <math>t_{prd}</math>, <math>t_{ps}</math>, <math>t_{pcd}</math>, <math>t_{ph}</math> and the deviation from the nominal time line.</li> </ul> |
| Expected Results       | The recording PMMS signals should match the timing as depicted in Figure 12. The values should be within the tolerances specified in Table 13. For the time $t_{hp}$ also observe the NOTE below.                                                                                                                                                                                                                                                                                                                                                                                                                                                                                                                                                                                                                                                                                                                                                                                                                                                                                                               |

**4.6.1.1 Expected Results**

The recorded preactivation sequence should match the timing as defined in Figure 12 and Table 13.



**Figure 12: Typical timing diagram for pre-activation sequence**

**TABLE 13: TIMING FOR PRE-ACTIVATION SIGNALS**

| Time                 | Parameter                                                                                              | Nominal value                  | Tolerance |
|----------------------|--------------------------------------------------------------------------------------------------------|--------------------------------|-----------|
| t <sub>hp</sub>      | Time from end of handshake to start of remote probe                                                    | 0.2 s                          | ±10 ms    |
| t <sub>prd</sub>     | Duration of remote probe                                                                               | Selectable from 50 ms to 3.1 s | ±10 ms    |
| t <sub>ps</sub>      | Time separating two probe sequences                                                                    | 0.2 s                          | ±10 ms    |
| t <sub>prc</sub>     | Time separating last remote and first central probe sequences                                          | 0.2 s                          | ±10 ms    |
| t <sub>pcd</sub>     | Duration of central probe                                                                              | Selectable from 50 ms to 3.1 s | ±10 ms    |
| t <sub>ph</sub>      | Time from end of central probe to start of handshake                                                   | 0.2 s                          | ±10 ms    |
| t <sub>p-total</sub> | Total probe duration, from end of the first G.994.1 session to the start of the second G.994.1 session | 10 s maximum                   |           |

NOTE – Tolerances are relative to the nominal or ideal value. They are not cumulative across the pre-activation sequence.

IMPORTANT NOTE: Concerning the time t<sub>hp</sub> the following points are to consider:

- According to G.994.1 the end of G.handshake can differ on COT and CPE side by up to 500ms. Therefore it would be possible that the COT is still in its handshake procedure while the CPE is already sending its remote probes. Thus the end of handshake should be defined more accurate when starting a PMMS session afterwards.
- For purposes of this test, it is proposed that the end of the handshake session is the point of time when the closing GALF signal ends, for both the COT and the CPE, with a

tolerance of +/- 10ms. The CPE shall send its remote probes  $t_{hp}$  after this point in time and the COT shall be ready to receive the remote probes  $t_{hp}$  after this point in time.

#### 4.6.2 PMMS Signal Compliance Test

##### **Test setup**

STU-R and STU-C are connected at both sides of the SHDSL line simulator as depicted in Figure 11. The loop length should be 1000m. The storage oscilloscope is used to record the preactivation sequence, from which the signals can be taken. The test shall be performed with the noise generator removed or turned off. The devices shall be in normal operational mode using PMMS (rate adaptive).

|                        |                                                                                                                                                                                                                                                                                                                                                                                                                                                                                                                                                                                                                                                                                                                                                                                                                                                                                                                                                                                                                                            |
|------------------------|--------------------------------------------------------------------------------------------------------------------------------------------------------------------------------------------------------------------------------------------------------------------------------------------------------------------------------------------------------------------------------------------------------------------------------------------------------------------------------------------------------------------------------------------------------------------------------------------------------------------------------------------------------------------------------------------------------------------------------------------------------------------------------------------------------------------------------------------------------------------------------------------------------------------------------------------------------------------------------------------------------------------------------------------|
| Test Case Identifier   | SH-4640-00                                                                                                                                                                                                                                                                                                                                                                                                                                                                                                                                                                                                                                                                                                                                                                                                                                                                                                                                                                                                                                 |
| Test Case Name         | PMMS Signal Compliance                                                                                                                                                                                                                                                                                                                                                                                                                                                                                                                                                                                                                                                                                                                                                                                                                                                                                                                                                                                                                     |
| Test Purpose           | This test case is to verify that the PMMS probe signals and silence signals are within certain tolerances to ensure PMMS interoperability between different devices.                                                                                                                                                                                                                                                                                                                                                                                                                                                                                                                                                                                                                                                                                                                                                                                                                                                                       |
| Standard Requirement   | ITU-T G.991.2, Section 6.3, ITU-T G.994.1 Annex B                                                                                                                                                                                                                                                                                                                                                                                                                                                                                                                                                                                                                                                                                                                                                                                                                                                                                                                                                                                          |
| Additional Information | <ul style="list-style-type: none"> <li>Set STU-C and STU-R to use PMMS (Line Probing, Rate Adaptive). Optional if supported</li> </ul>                                                                                                                                                                                                                                                                                                                                                                                                                                                                                                                                                                                                                                                                                                                                                                                                                                                                                                     |
| Procedure              | <ul style="list-style-type: none"> <li>Connect modems with 0m loop with the noise turned off.</li> <li>Specify the probe settings requested by each of the STUs.</li> <li>Start preactivation.</li> <li>The oscilloscope setup for this test will vary depending upon the make and model. However, an appropriate sweep time, sampling rate and amplitude resolution should be used to ensure that silence and probe signals are stored properly. With this criteria met, the user will be able to allow the oscilloscope to free run until the preactivation signals of interest are transmitted. Then the storage oscilloscope should be stopped so that the preactivation signals can be reviewed for compliance.</li> </ul> <p>The preactivation signals can be verified through the use of the measurement functions of the oscilloscope.</p> <ul style="list-style-type: none"> <li>Check the quality of all probe signals and of the silence signals from handshake to first remote probe and between subsequent probes.</li> </ul> |
| Expected Results       | <p>The transmit power of the recorded probe signals should be within the requirements specified in G.991.2.</p> <p>The recorded silence signal between handshake and the first remote probe and between all other probes shall fulfill the requirements specified below.</p>                                                                                                                                                                                                                                                                                                                                                                                                                                                                                                                                                                                                                                                                                                                                                               |

#### **4.6.2.1 Expected results**

As specified in G.991.2 the probe signals Pci and Pri should be sent with the same signal power level as during activation, i.e. nominally 13.5dBm for annex A or 14.5dBm for annex B, rates  $\geq$  2048kbps.

For the purpose of this test, it is proposed that the silence signal between handshake and the first remote probe and between all other probes shall fulfill following restrictions:

- The average silence power transmitted should be at any time at least 40dB lower than the transmitted probe signal power.
- The amplitude of the transmitted signal from the transceiver at silence condition should at no time exceed a level of 30dB lower than the maximum probe signal amplitude.

### **4.7 4-Wire Mode**

#### **4.7.1 4-Wire Mode start-up description**

- R-Tones-Req (for STU-R initiated start-up) and C-Tones shall be transmitted simultaneously on all available wire pairs.
- The STU-R shall then select an active wire pair from the set of pairs on which it receives C-Tones.
- R-Tone1, R-Flag1, and all succeeding signals transmitted by the HSTU-R shall only be transmitted on the selected active wire pair. Silence shall be sent on the other pairs.
- The STU-C shall designate the pair on which R-Tone1 and/or R-Flag1 is received as its active pair.
- All succeeding signals transmitted by the STU-C shall only be transmitted on the designated active wire pair. Silence shall be sent on the other pairs.
- The active pair is referred to as Pair1 (“Master”) while the second, not active, pair is named Pair2 (“Slave”).

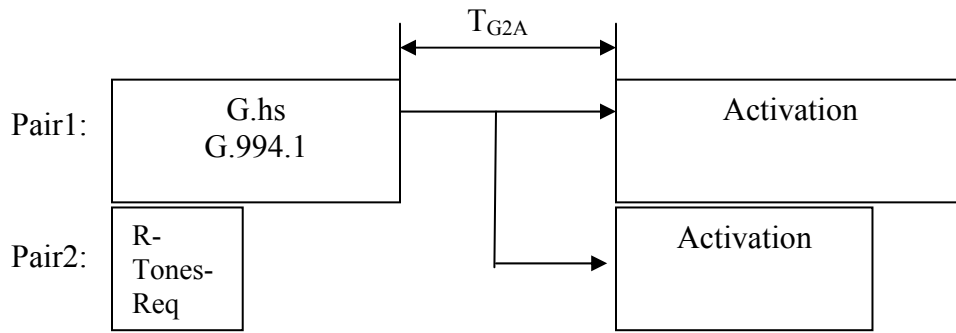

**Figure 13: 4-Wire Mode Start-up**

STU-C:

| Time      | Parameter                                                                                                      | Nominal Value                                                                  |
|-----------|----------------------------------------------------------------------------------------------------------------|--------------------------------------------------------------------------------|
| $T_{G2A}$ | Time from end of handshake to start of activation, i.e. the remote signal Cr (Cr is variable, see Note below.) | Pair 1: $0.34 < T_{G2A} \leq 1.3$ sec<br>Pair 2: $0.34 < T_{G2A} \leq 1.3$ sec |

STU-R:

|           |                                                                              |                                                                          |
|-----------|------------------------------------------------------------------------------|--------------------------------------------------------------------------|
| $T_{G2A}$ | Time from end of handshake to start of activation, i.e. the remote signal Cr | Pair 1: $0.34 < T_{G2A} < 1.3$ sec<br>Pair 2: $0.34 < T_{G2A} < 1.3$ sec |
|-----------|------------------------------------------------------------------------------|--------------------------------------------------------------------------|

NOTE: According to Amendment 1 of Recommendation G.991.2, “The end of preactivation can be defined in two ways according to the G.994.1 document. For the purpose of this Recommendation, the end of preactivation will be from the end of the ACK (1) message transmission plus the required timers. The minimum and maximum values of those timers are 0.04 and 1.0 second. Therefore, the total time between the end of ACK(1) message and the beginning of Cr should be between 0.34 and 1.3 s.”

**4.7.2 4-Wire Mode start-up description with Lineprobing**

The first G.994.1 exchange shall follow the defined procedures for multi-pair operation (ITU-T G.994.1 Annex B), as described in the previous chapter. The Lineprobing Signals (ITU-T G.991.2 clause 6.3.2), shall be sent in parallel on both wire pairs. Pair 1 and Pair 2 shall be determined during the first preactivation sequence. The second G.994.1 exchange shall only be performed on Pair 1, i.e. on Pair 2 no signal is transmitted after Lineprobing.

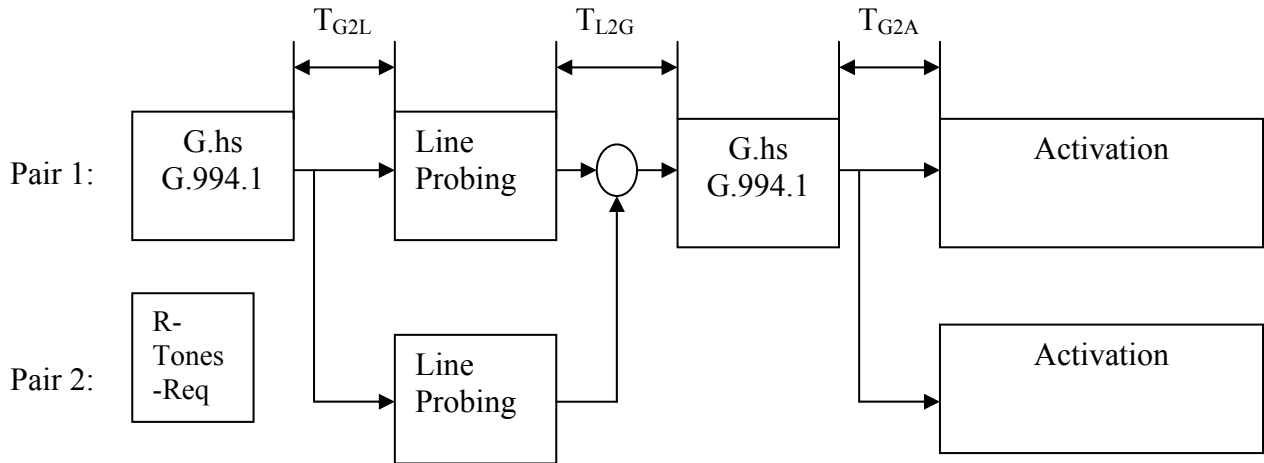

**Figure 14: Overview of 4-Wire Mode Start-up Timing with Lineprobing**

STU-C:

| Time      | Parameter                                                                                       | Nominal Value                                                                                                  |
|-----------|-------------------------------------------------------------------------------------------------|----------------------------------------------------------------------------------------------------------------|
| $T_{G2L}$ | Time from end of handshake to start of Lineprobing, i.e. the first remote (STU_R) probe         | Pair 1: $T_{G2L} = 0,2 \text{ sec} \pm 10 \text{ ms}$<br>Pair 2: $T_{G2L} = 0,2 \text{ sec} \pm 10 \text{ ms}$ |
| $T_{L2G}$ | Time from end of lineprobing, i.e. the last central (STU_C) probe, to start of second handshake | Pair 1: $T_{L2G} = 0,2 \text{ sec} \pm 10 \text{ ms}$<br>Pair 2: none                                          |
| $T_{G2A}$ | Time from end of handshake to start of activation, i.e. the remote signal Cr                    | Pair 1: $0,34 < T_{G2A} \leq 1,3 \text{ sec}$<br>Pair 2: $0,34 < T_{G2A} \leq 1,3 \text{ sec}$                 |

STU-R:

|           |                                                                                                 |                                                                                                                |
|-----------|-------------------------------------------------------------------------------------------------|----------------------------------------------------------------------------------------------------------------|
| $T_{G2L}$ | Time from end of handshake to start of Lineprobing, i.e. the first remote (STU_R) probe         | Pair 1: $T_{G2L} = 0,2 \text{ sec} \pm 10 \text{ ms}$<br>Pair 2: $T_{G2L} = 0,2 \text{ sec} \pm 10 \text{ ms}$ |
| $T_{L2G}$ | Time from end of Lineprobing, i.e. the last central (STU_C) probe, to start of second handshake | Pair 1: $T_{L2G} = 0,2 \text{ sec} \pm 10 \text{ ms}$<br>Pair 2: none                                          |
| $T_{G2A}$ | Time from end of handshake to start of activation, i.e. the remote signal Cr                    | Pair 1: $0,34 < T_{G2A} < 1,3 \text{ sec}$<br>Pair 2: $0,34 < T_{G2A} < 1,3 \text{ sec}$                       |

Note: The time  $T_{G2L}$  is not identical to  $T_{G2A}$  as described in the Implementer’s Guide (Amendment FC-020). It describes the time between the end of GALF and the first (STU\_R) probe.

### 4.7.3 Test Setup

STU-R and STU-C are connected together as depicted in Figure 15. The storage oscilloscope is used to record the pre-activation sequence,

|                        |                                                                                                                                                                                                                                                                                                                                                                                                                                                                                                                                                                                                                                                                                                                                                                                                                                                                                                                                                                                                               |
|------------------------|---------------------------------------------------------------------------------------------------------------------------------------------------------------------------------------------------------------------------------------------------------------------------------------------------------------------------------------------------------------------------------------------------------------------------------------------------------------------------------------------------------------------------------------------------------------------------------------------------------------------------------------------------------------------------------------------------------------------------------------------------------------------------------------------------------------------------------------------------------------------------------------------------------------------------------------------------------------------------------------------------------------|
| Test Case Identifier   | SH-4730-00                                                                                                                                                                                                                                                                                                                                                                                                                                                                                                                                                                                                                                                                                                                                                                                                                                                                                                                                                                                                    |
| Test Case Name         | 4-Wire Mode startup test                                                                                                                                                                                                                                                                                                                                                                                                                                                                                                                                                                                                                                                                                                                                                                                                                                                                                                                                                                                      |
| Test Purpose           | To verify the correct start-up of the DTUs in 4-wire mode with and without lineprobing. These modes are optional and may not be supported by all devices.                                                                                                                                                                                                                                                                                                                                                                                                                                                                                                                                                                                                                                                                                                                                                                                                                                                     |
| Standard Requirement   | ITU-T G.994.1 Annex B<br>ITU-T G.991.2 clause 6.3                                                                                                                                                                                                                                                                                                                                                                                                                                                                                                                                                                                                                                                                                                                                                                                                                                                                                                                                                             |
| Additional Information | <ul style="list-style-type: none"> <li>during time <math>T_{G2A}</math> both STU's shall transmit silence</li> <li>See 4.7.1 4-Wire Mode Description and 4.7.2 4-Wire Mode Description with Lineprobing</li> <li>both pairs shall the core activation at the same time. Therefore they should reach data mode nearly simultaneously.</li> <li>The core activation is identical to the 2-wire mode and can be tested according to appropriate procedures as described in the previous chapters.</li> </ul>                                                                                                                                                                                                                                                                                                                                                                                                                                                                                                     |
| Procedure              | <ul style="list-style-type: none"> <li>Connect modems according to test setup</li> <li>The oscilloscope setup for the 4-wire sequence timing test will vary depending upon the make and model. However, an appropriate sweep time and sampling rate should be used to ensure that the entire 4-wire sequence of up to 25 seconds is stored. With this criteria met, the user will be able to allow the oscilloscope to free run until the units achieve data mode. Then the storage oscilloscope should be stopped so that the 4-wire sequence can be reviewed for compliance. The 4-wire timing can be verified through the use of the measurement functions of the oscilloscope.</li> <li>Measure <math>T_{G2L}</math>, <math>T_{L2G}</math>, <math>T_{G2A}</math>.</li> <li>Check if during time <math>T_{G2A}</math> both STU's are transmitting silence</li> <li>Check if both pairs are starting their Cr Signal simultaneously</li> <li>Repeat the above procedure with crossed wire pairs.</li> </ul> |
| Expected Results       | The recorded 4-Wire Mode sequence should be as shown in Figure 13 and Figure 14. The recorded timing values should be within the tolerances specified in the Tables above. In all cases, also with switched pairs, data shall be transmitted correctly.                                                                                                                                                                                                                                                                                                                                                                                                                                                                                                                                                                                                                                                                                                                                                       |



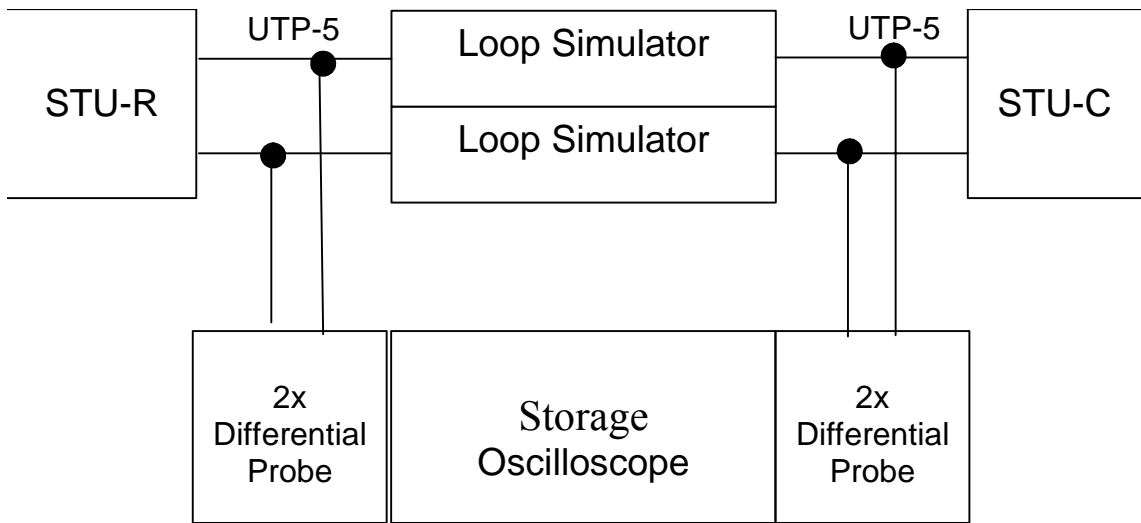

**Figure 15: Test Setup to Check 4-Wire Mode Start-up with Lineprobing**

## 5 System Interoperability

The Embedded Operations Channel (EOC) allows terminal units to maintain information about the connection or span, and commands requesting certain actions to be taken by a STU-x unit. There are two basic categories of flows, differentiated by which unit initiates the data flow (and subsequently stores the information for external access). The data flow origination from the STU-C is mandatory. The data flow initiating from the STU-R is optional, but all units (repeaters/regenerators) must respond to requests in either direction of data flow. In all cases, the “master database” shall be stored at the STU-C and all conflicts shall be resolved in favor of the STU-C.

When the optional 4-wire mode is supported, the same EOC message is required to be passed by both loops. To verify, apply the following test cases either using one in Data mode and the other disconnected or both in data mode.

EOC messages are a key part of the start-up procedures and includes Discovery, Inventory, and Configuration Responses from remote units during startup before going in service. Incorrect implementation of the EOC has been a common cause of interoperability problems. Correct responses enable the network to "see" what types of units are connected (CPE and/or repeaters), identify the vendor, what software is running, etc. Other messages are sent during startup but they should not affect going into service. Some hints where problems frequently occur include:

- All EOC messages should have correct message length
- Discovery Response (#129) must have a valid hop count (incremented +1). See Recommendation G.991.2 Section 9.5.5.7.2.

- Configuration Request threshold settings default to 0, which means they are turned off. If an STU-R does not support threshold configuration, it should first check if the request is to turn off the thresholds. If so, send a Configuration Response that acknowledges that the thresholds have been turned off.
- The STU-R must implement the power status bit (ps bit) in the overhead of the SHDSL frame. Otherwise, a Loss of Power (LPR) alarm will be generated and prevent the line from achieving or maintaining sync. (See G.991.2 Frame Structure Table 7-1 in Section 7.1.2.5.3).

The EOC Maintenance Requests provide another category of important messages to enable performance status, ATM cell status, loopback, loopback timeout, and soft restart messages to be communicated, and are important to operators.

The EOC critical messaging capabilities are verified in the test cases contained in the following sections.

## **5.1 Loop back Control Structure Tests**

The Loop back Control Structure tests will apply to STU devices depending on function. The two types of operation are CO Control Mode and Remote Control Mode.

### **5.1.1 CO Control Mode**

The following tests are applicable when the user is controlling all loop backs at the STU-C. If 4-wire mode is supported, the same test should be applied to each pair.

#### **5.1.1.1 CO Control Mode: System Loop back Message (9) Broadcast**

This set of tests is applicable for any STU-R when the STU-C controls loop back with a system loop back message broadcast to the other units in this system.

##### **5.1.1.1.1 Network Loop back at Remote**

###### **A) Activate Network Loop back at Remote**

|                      |                                                                                                                                                                                                                                                                                                                                                                    |
|----------------------|--------------------------------------------------------------------------------------------------------------------------------------------------------------------------------------------------------------------------------------------------------------------------------------------------------------------------------------------------------------------|
| Test Case Identifier | SH-5111-10                                                                                                                                                                                                                                                                                                                                                         |
| Test Case Name       | Loop Back at Remote                                                                                                                                                                                                                                                                                                                                                |
| Test Purpose         | Test loop back activation from remote equipment                                                                                                                                                                                                                                                                                                                    |
| Standard Requirement |                                                                                                                                                                                                                                                                                                                                                                    |
| Procedure            | Activate network loop back at remote from CO unit                                                                                                                                                                                                                                                                                                                  |
| Expected Results     | <ul style="list-style-type: none"> <li>• Verify control for initiate loop back toward the network in command for STU-R (octet 3 bit 3) set in system loop back message</li> <li>• Verify error free payload data looped back towards network</li> <li>• Verify maintenance status message from remote in response to status request message (msg id 11)</li> </ul> |

|  |                                                                   |
|--|-------------------------------------------------------------------|
|  | indicates a network loop back is active at remote (octet 2 bit 3) |
|--|-------------------------------------------------------------------|

## B) Deactivate Network Loop back at Remote

Test both methods of deactivation

|                      |                                                                                                                                                                                                                                                                                                                                                                                                                                                                        |
|----------------------|------------------------------------------------------------------------------------------------------------------------------------------------------------------------------------------------------------------------------------------------------------------------------------------------------------------------------------------------------------------------------------------------------------------------------------------------------------------------|
| Test Case Identifier | SH-5111-11                                                                                                                                                                                                                                                                                                                                                                                                                                                             |
| Test Case Name       | Deactivate Network Loop back at Remote                                                                                                                                                                                                                                                                                                                                                                                                                                 |
| Test Purpose         | Test correct deactivation                                                                                                                                                                                                                                                                                                                                                                                                                                              |
| Standard Requirement |                                                                                                                                                                                                                                                                                                                                                                                                                                                                        |
| Procedure            | Deactivate loop back at remote to network from CO unit using terminate loop back toward network in system loop back message.                                                                                                                                                                                                                                                                                                                                           |
| Expected Results     | <ul style="list-style-type: none"> <li>• Verify control for terminate loop back toward the network in command for STU-R (octet 3 bit 1) set in system loop back message.</li> <li>• Verify loop back dropped and data path restored.</li> <li>• Verify maintenance status message from remote in response to status request message (Msg id 11) immediately after looping down indicates a network loop back is no longer active at remote (octet 2, bit3).</li> </ul> |

|                      |                                                                                                                                                                                                                                                                                                                                                                                                                                                           |
|----------------------|-----------------------------------------------------------------------------------------------------------------------------------------------------------------------------------------------------------------------------------------------------------------------------------------------------------------------------------------------------------------------------------------------------------------------------------------------------------|
| Test Case Identifier | SH-5111-12                                                                                                                                                                                                                                                                                                                                                                                                                                                |
| Test Case Name       | Deactivate Network Loop back at Remote                                                                                                                                                                                                                                                                                                                                                                                                                    |
| Test Purpose         | Test correct deactivation                                                                                                                                                                                                                                                                                                                                                                                                                                 |
| Standard Requirement |                                                                                                                                                                                                                                                                                                                                                                                                                                                           |
| Procedure            | Deactivate loop back at remote to network from CO unit using clear all maintenance states in system loop back message.                                                                                                                                                                                                                                                                                                                                    |
| Expected Results     | <ul style="list-style-type: none"> <li>• Verify control for clear all maintenance states in command for STU-R (octet 3, bit 6) in system loop back message</li> <li>• Verify loop back dropped and data path restored.</li> <li>• Verify maintenance status message from remote in response to status request message (Msg id 11) immediately after looping down indicates a network loop back is no longer active at remote (octet 2, bit 3).</li> </ul> |

**5.1.1.1.2 Customer Loop back at Remote****A) Activate Customer Loop back at Remote**

|                      |                                                                                                                                                                                                                                                                                                                                                                                                                                         |
|----------------------|-----------------------------------------------------------------------------------------------------------------------------------------------------------------------------------------------------------------------------------------------------------------------------------------------------------------------------------------------------------------------------------------------------------------------------------------|
| Test Case Identifier | SH-5111-20                                                                                                                                                                                                                                                                                                                                                                                                                              |
| Test Case Name       | Activate Customer Loop Back at Remote                                                                                                                                                                                                                                                                                                                                                                                                   |
| Test Purpose         | Test for correct operation                                                                                                                                                                                                                                                                                                                                                                                                              |
| Standard Requirement |                                                                                                                                                                                                                                                                                                                                                                                                                                         |
| Procedure            | Activate customer loop back at remote from CO unit                                                                                                                                                                                                                                                                                                                                                                                      |
| Expected Results     | <ul style="list-style-type: none"> <li>• Verify control for initiate loop back toward the customer in command for STU-R (octet 3 bit 3) set in system loop back message</li> <li>• Verify error free payload data looped back towards customer</li> <li>• Verify maintenance status message from remote in response to status request message (msg id 11) indicates a customer loop back is active at remote (octet 2 bit 4)</li> </ul> |

**A) Deactivate Customer Loop back at Remote**

Test both methods of deactivation:

|                      |                                                                                                                                                                                                                                                                                                                                                                                                                                                                          |
|----------------------|--------------------------------------------------------------------------------------------------------------------------------------------------------------------------------------------------------------------------------------------------------------------------------------------------------------------------------------------------------------------------------------------------------------------------------------------------------------------------|
| Test Case Identifier | SH-5111-21                                                                                                                                                                                                                                                                                                                                                                                                                                                               |
| Test Case Name       | Deactivate Customer Loop back at Remote                                                                                                                                                                                                                                                                                                                                                                                                                                  |
| Test Purpose         | Test for correct operation                                                                                                                                                                                                                                                                                                                                                                                                                                               |
| Standard Requirement |                                                                                                                                                                                                                                                                                                                                                                                                                                                                          |
| Procedure            | Deactivate customer loop back at remote from CO unit using terminate loop back toward customer in system loop back message                                                                                                                                                                                                                                                                                                                                               |
| Expected Results     | <ul style="list-style-type: none"> <li>• Verify control for terminate loop back toward the customer in command for STU-R (octet 3 bit 0) set in system loop back message.</li> <li>• Verify loop back dropped and data path restored.</li> <li>• Verify maintenance status message from remote in response to status request message (Msg id 11) immediately after looping down indicates a network loop back is no longer active at remote (octet 2, bit 4).</li> </ul> |

|                      |                                                                                                                                                                                                                                                                                                                                                                                                                                                           |
|----------------------|-----------------------------------------------------------------------------------------------------------------------------------------------------------------------------------------------------------------------------------------------------------------------------------------------------------------------------------------------------------------------------------------------------------------------------------------------------------|
| Test Case Identifier | SH-5111-22                                                                                                                                                                                                                                                                                                                                                                                                                                                |
| Test Case Name       | Deactivate Customer Loop back at Remote                                                                                                                                                                                                                                                                                                                                                                                                                   |
| Test Purpose         | Test for correct operation                                                                                                                                                                                                                                                                                                                                                                                                                                |
| Standard Requirement |                                                                                                                                                                                                                                                                                                                                                                                                                                                           |
| Procedure            | Deactivate loop back at remote to customer from CO unit using clear all maintenance states in system loop back message.                                                                                                                                                                                                                                                                                                                                   |
| Expected Results     | <ul style="list-style-type: none"> <li>• Verify only control for clear all maintenance states in command for STU-R (octet 3, bit 6) in system loop back message</li> <li>• Verify back dropped and data path restores.</li> <li>• Verify maintenance status message from remote in response to status request message (Msg id 11) immediately after looping down indicates a network loop back is no longer active at remote (octet 2, bit 4).</li> </ul> |

#### 5.1.1.1.3 Bi-directional Loop back at Remote (If supported by both ends)

##### A) **Activate Bi-directional Loop back at Remote**

|                        |                                                                                                                                                                                                                                                                                                                                                                                                                                                                                                                                                                                                                                                                                |
|------------------------|--------------------------------------------------------------------------------------------------------------------------------------------------------------------------------------------------------------------------------------------------------------------------------------------------------------------------------------------------------------------------------------------------------------------------------------------------------------------------------------------------------------------------------------------------------------------------------------------------------------------------------------------------------------------------------|
| Test Case Identifier   | SH-5111-30                                                                                                                                                                                                                                                                                                                                                                                                                                                                                                                                                                                                                                                                     |
| Test Case Name         | Activate Bi-directional Loop back at Remote                                                                                                                                                                                                                                                                                                                                                                                                                                                                                                                                                                                                                                    |
| Test Purpose           | Test for correct operation                                                                                                                                                                                                                                                                                                                                                                                                                                                                                                                                                                                                                                                     |
| Standard Requirement   |                                                                                                                                                                                                                                                                                                                                                                                                                                                                                                                                                                                                                                                                                |
| Additional Information | (Note may have to activate one direction at a time)                                                                                                                                                                                                                                                                                                                                                                                                                                                                                                                                                                                                                            |
| Procedure              | Activate bi-directional loop back at remote from CO unit.                                                                                                                                                                                                                                                                                                                                                                                                                                                                                                                                                                                                                      |
| Expected Results       | <ul style="list-style-type: none"> <li>• Verify control for initiate loop back toward the network and customer in command for STU-R (octet 3, bit 2 and 3) are set in system loop back message.</li> <li>• Verify error free payload data looped back towards both network and customer</li> <li>• Verify maintenance status message from remote to CO in response to status request message (msg id 11) indicates network and customer Loop backs are active at remote (octet 2, bit 3 and 4)</li> <li>• If the remote cannot support multiple loop back requests, it shall respond with a maintenance status message that indicates its current active loop back.</li> </ul> |

**B) Deactivate Bi-directional Loop back at Remote**

Test both methods of deactivation

|                        |                                                                                                                                                                                                                                                                                                                                                                                                                                                                                                                      |
|------------------------|----------------------------------------------------------------------------------------------------------------------------------------------------------------------------------------------------------------------------------------------------------------------------------------------------------------------------------------------------------------------------------------------------------------------------------------------------------------------------------------------------------------------|
| Test Case Identifier   | SH-5111-31                                                                                                                                                                                                                                                                                                                                                                                                                                                                                                           |
| Test Case Name         | Deactivate Bi-directional Loop back at Remote                                                                                                                                                                                                                                                                                                                                                                                                                                                                        |
| Test Purpose           | Test for correct operation                                                                                                                                                                                                                                                                                                                                                                                                                                                                                           |
| Standard Requirement   |                                                                                                                                                                                                                                                                                                                                                                                                                                                                                                                      |
| Additional Information |                                                                                                                                                                                                                                                                                                                                                                                                                                                                                                                      |
| Procedure              | Deactivate bi-directional loop backs at remote from CO unit using terminate loop back toward customer and network in system loop back message                                                                                                                                                                                                                                                                                                                                                                        |
| Expected Results       | <ul style="list-style-type: none"> <li>• Verify control for terminate loop back toward the network and customer in command for STU-R (octet3, bits 0 and 1) are set in system loop back message.</li> <li>• Verify loop back dropped and data path restored.</li> <li>• Verify maintenance status message from remote in response to status request message (msg id 11) immediately after looping down indicates the network and customer loop back are no longer active at remote (octet 2, bit 3 and 4)</li> </ul> |

|                        |                                                                                                                                                                                                                                                                                                                                                                                                                                                                                        |
|------------------------|----------------------------------------------------------------------------------------------------------------------------------------------------------------------------------------------------------------------------------------------------------------------------------------------------------------------------------------------------------------------------------------------------------------------------------------------------------------------------------------|
| Test Case Identifier   | SH-5111-32                                                                                                                                                                                                                                                                                                                                                                                                                                                                             |
| Test Case Name         | Deactivate Bi-directional Loop back at Remote                                                                                                                                                                                                                                                                                                                                                                                                                                          |
| Test Purpose           | Test for correct operation                                                                                                                                                                                                                                                                                                                                                                                                                                                             |
| Standard Requirement   |                                                                                                                                                                                                                                                                                                                                                                                                                                                                                        |
| Additional Information |                                                                                                                                                                                                                                                                                                                                                                                                                                                                                        |
| Procedure              | Deactivate loop back at remote from CO unit using clear all maintenance states in system loop back message.                                                                                                                                                                                                                                                                                                                                                                            |
| Expected Results       | <ul style="list-style-type: none"> <li>• Verify control for clear all maintenance states in command for STU-R (octet 3, bit 6) is set in system loop back message.</li> <li>• Verify loop back dropped and data path restored.</li> <li>• Verify maintenance status message from remote in response to status request message (msg id 11) immediately after looping down indicates the network and customer loop back are no longer active at remote (octet 2, bit 3 and 4)</li> </ul> |

**5.1.1.1.4 Special Loop back at Remote (if supported)****A) Activate Special Loop back at Remote to Network**

|                        |                                                                                                                                                                                                                                                                                                                                                                                                             |
|------------------------|-------------------------------------------------------------------------------------------------------------------------------------------------------------------------------------------------------------------------------------------------------------------------------------------------------------------------------------------------------------------------------------------------------------|
| Test Case Identifier   | SH-5111-40                                                                                                                                                                                                                                                                                                                                                                                                  |
| Test Case Name         | Activate Special Loop back at Remote to Network                                                                                                                                                                                                                                                                                                                                                             |
| Test Purpose           | Test for correct operation if supported                                                                                                                                                                                                                                                                                                                                                                     |
| Standard Requirement   |                                                                                                                                                                                                                                                                                                                                                                                                             |
| Additional Information |                                                                                                                                                                                                                                                                                                                                                                                                             |
| Procedure              | Activate special loop back to network from CO unit.                                                                                                                                                                                                                                                                                                                                                         |
| Expected Results       | <ul style="list-style-type: none"> <li>• Verify control for special remote loop back (Octet 3, bit 5) is set in system loop back message.</li> <li>• Verify error free payload data is looped back towards network</li> <li>• Verify maintenance status message from remote in response to status request message (msg id 11) indicates a special loop back is active at remote (octet 2, bit 5)</li> </ul> |

**B) Deactivate Network Loop back Remote to Network**

|                        |                                                                                                                                                                                                                                                                                                                                                                                                                                                                  |
|------------------------|------------------------------------------------------------------------------------------------------------------------------------------------------------------------------------------------------------------------------------------------------------------------------------------------------------------------------------------------------------------------------------------------------------------------------------------------------------------|
| Test Case Identifier   | SH-5111-41                                                                                                                                                                                                                                                                                                                                                                                                                                                       |
| Test Case Name         | Deactivate Network Loop back Remote to Network                                                                                                                                                                                                                                                                                                                                                                                                                   |
| Test Purpose           | Test for correct operation if supported                                                                                                                                                                                                                                                                                                                                                                                                                          |
| Standard Requirement   |                                                                                                                                                                                                                                                                                                                                                                                                                                                                  |
| Additional Information |                                                                                                                                                                                                                                                                                                                                                                                                                                                                  |
| Procedure              | Deactivate loop back at remote to network from CO unit using terminate special loop back (octet 3 bit4) in system loop back message                                                                                                                                                                                                                                                                                                                              |
| Expected Results       | <ul style="list-style-type: none"> <li>• Verify control for clear all maintenance states in command for STU-R (octet 3, bit 6) is set in system loop back message.</li> <li>• Verify loop back dropped and data path restored.</li> <li>• Verify maintenance status message from remote in response to status request message (msg id 11) immediately after looping down indicates a network loop back is no longer active at remote (octet 2, bit 4)</li> </ul> |

|                        |                                                                                                                                                                                                                                                                                                                                                                                                                                                                  |
|------------------------|------------------------------------------------------------------------------------------------------------------------------------------------------------------------------------------------------------------------------------------------------------------------------------------------------------------------------------------------------------------------------------------------------------------------------------------------------------------|
| Test Case Identifier   | SH-5111-42                                                                                                                                                                                                                                                                                                                                                                                                                                                       |
| Test Case Name         | Deactivate Network Loop back Remote to Network                                                                                                                                                                                                                                                                                                                                                                                                                   |
| Test Purpose           | Test for correct operation if supported                                                                                                                                                                                                                                                                                                                                                                                                                          |
| Standard Requirement   |                                                                                                                                                                                                                                                                                                                                                                                                                                                                  |
| Additional Information |                                                                                                                                                                                                                                                                                                                                                                                                                                                                  |
| Procedure              | Deactivate loop back at remote to network from CO unit using clear all maintenance states (octet 3 bit 6) in system loop back message.                                                                                                                                                                                                                                                                                                                           |
| Expected Results       | <ul style="list-style-type: none"> <li>• Verify control for clear all maintenance states in command for STU-R (octet 3, bit 6) is set in system loop back message.</li> <li>• Verify loop back dropped and data path restored.</li> <li>• Verify maintenance status message from remote in response to status request message (msg id 11) immediately after looping down indicates a network loop back is no longer active at remote (octet 2, bit 4)</li> </ul> |

#### 5.1.1.2 CO Control Mode: Element Loop back Message (10)

The remote end in test cases in this section can be STU-R or SRU depending on which octet in message 10 has the bit 3 set to activate the loopback of that particular element. In this section, STU-R is used only as an example.

##### 5.1.1.2.1 Network Loop back at Remote

#### A) Activate Network Loop back at Remote

|                        |                                                                                                                                                                                                                                                        |
|------------------------|--------------------------------------------------------------------------------------------------------------------------------------------------------------------------------------------------------------------------------------------------------|
| Test Case Identifier   | SH-5112-10                                                                                                                                                                                                                                             |
| Test Case Name         | Activate Network Loop back at Remote                                                                                                                                                                                                                   |
| Test Purpose           | Test for correct operation                                                                                                                                                                                                                             |
| Standard Requirement   |                                                                                                                                                                                                                                                        |
| Additional Information |                                                                                                                                                                                                                                                        |
| Procedure              | Activate network loop back at remote from CO unit                                                                                                                                                                                                      |
| Expected Results       | <ul style="list-style-type: none"> <li>• Verify Octet 2 Bit 3 is set in Element Loop back message addressed to STU-R</li> <li>• Verify error free payload is looped back towards CO</li> <li>• Verify maintenance status message from STU-R</li> </ul> |



|  |                                                                |
|--|----------------------------------------------------------------|
|  | indicates a loop back is active towards STU-C (Octet 2, Bit 3) |
|--|----------------------------------------------------------------|

## B) Deactivate Network Loop back at Remote

Test both methods of deactivation

|                        |                                                                                                                                                                                                                                                                                                                                                                       |
|------------------------|-----------------------------------------------------------------------------------------------------------------------------------------------------------------------------------------------------------------------------------------------------------------------------------------------------------------------------------------------------------------------|
| Test Case Identifier   | SH-5112-11                                                                                                                                                                                                                                                                                                                                                            |
| Test Case Name         | Deactivate Network Loop back at Remote                                                                                                                                                                                                                                                                                                                                |
| Test Purpose           | Test for correct operation                                                                                                                                                                                                                                                                                                                                            |
| Standard Requirement   |                                                                                                                                                                                                                                                                                                                                                                       |
| Additional Information |                                                                                                                                                                                                                                                                                                                                                                       |
| Procedure              | Deactivate loop back at remote to network from CO unit using terminate loop back toward network in element loop back message.                                                                                                                                                                                                                                         |
| Expected Results       | <ul style="list-style-type: none"> <li>• Verify control for terminate loop back toward the network (octet 2, bit 1) is set in element loop back message.</li> <li>• Verify loop back dropped and data path restored.</li> <li>• Verify maintenance status message from remote indicates a network loop back is no longer active at remote (octet 2, bit3).</li> </ul> |

|                        |                                                                                                                                                                                                                                                                                                                                                            |
|------------------------|------------------------------------------------------------------------------------------------------------------------------------------------------------------------------------------------------------------------------------------------------------------------------------------------------------------------------------------------------------|
| Test Case Identifier   | SH-5112-12                                                                                                                                                                                                                                                                                                                                                 |
| Test Case Name         | Deactivate Network Loop back at Remote                                                                                                                                                                                                                                                                                                                     |
| Test Purpose           | Test for correct operation                                                                                                                                                                                                                                                                                                                                 |
| Standard Requirement   |                                                                                                                                                                                                                                                                                                                                                            |
| Additional Information |                                                                                                                                                                                                                                                                                                                                                            |
| Procedure              | Deactivate loop back at remote to network from CO unit. Using clear all maintenance states in element loop back message.                                                                                                                                                                                                                                   |
| Expected Results       | <ul style="list-style-type: none"> <li>• Verify control for clear all maintenance states (octet 2, bit 6) is set in element loop back message</li> <li>• Verify loop back dropped and data path restored.</li> <li>• Verify maintenance status message from remote indicates a network loop back is no longer active at remote (octet 2, bit3).</li> </ul> |

### 5.1.1.2.2 Customer Loopback at Remote

**A) Activate Customer Loopback at Remote**

|                      |                                                                                                                                                                                                                                                                                                                |
|----------------------|----------------------------------------------------------------------------------------------------------------------------------------------------------------------------------------------------------------------------------------------------------------------------------------------------------------|
| Test Case Identifier | SH-5112-20                                                                                                                                                                                                                                                                                                     |
| Test Case Name       | Activate Customer Loopback at Remote                                                                                                                                                                                                                                                                           |
| Test Purpose         | Test for correct operation                                                                                                                                                                                                                                                                                     |
| Standard Requirement |                                                                                                                                                                                                                                                                                                                |
| Procedure            | Activate customer loopback at remote from CO unit                                                                                                                                                                                                                                                              |
| Expected Results     | <ul style="list-style-type: none"> <li>• Verify Octet 2, Bit 2 is set in Element Loopback message addressed to STU-R</li> <li>• Verify error free payload data is looped back towards customer</li> <li>• Verify maintenance status message from STU-R indicates a loopback is active towards STU-R</li> </ul> |

**B) Deactivate Customer Loopback at Remote**

Test both methods of deactivation

|                      |                                                                                                                                                                                                                                                                                                                                                                    |
|----------------------|--------------------------------------------------------------------------------------------------------------------------------------------------------------------------------------------------------------------------------------------------------------------------------------------------------------------------------------------------------------------|
| Test Case Identifier | SH-5112-21                                                                                                                                                                                                                                                                                                                                                         |
| Test Case Name       | Deactivate Customer Loopback at Remote                                                                                                                                                                                                                                                                                                                             |
| Test Purpose         | Test for correct operation                                                                                                                                                                                                                                                                                                                                         |
| Standard Requirement |                                                                                                                                                                                                                                                                                                                                                                    |
| Procedure            | Deactivate customer loopback at remote from CO unit using terminate loopback toward customer (octet 2, bit 0) in element loopback message.                                                                                                                                                                                                                         |
| Expected Results     | <ul style="list-style-type: none"> <li>• Verify control for terminate loopback toward the customer (Octet 3, bit 0) is set in system loopback message.</li> <li>• Verify loopback dropped and data path restored.</li> <li>• Verify maintenance status message from remote indicates a customer loopback is no longer active at remote (octet 2, bit4).</li> </ul> |

|                      |                                                                                                                                        |
|----------------------|----------------------------------------------------------------------------------------------------------------------------------------|
| Test Case Identifier | SH-5112-22                                                                                                                             |
| Test Case Name       | Deactivate Customer Loopback at Remote                                                                                                 |
| Test Purpose         | Test for correct operation                                                                                                             |
| Standard Requirement |                                                                                                                                        |
| Procedure            | Deactivate loopback at remote to customer from CO unit using clear all maintenance states (Octet 2 bit 6) in element loopback message. |
| Expected Results     | <ul style="list-style-type: none"> <li>• Verify control for clear all maintenance states (Octet</li> </ul>                             |

|  |                                                                                                                                                                                                                                                                                               |
|--|-----------------------------------------------------------------------------------------------------------------------------------------------------------------------------------------------------------------------------------------------------------------------------------------------|
|  | <p>3 bit 6) is set in element loopback message</p> <ul style="list-style-type: none"> <li>• Verify loopback dropped and data path restored.</li> <li>• Verify maintenance status message from remote indicates a customer loopback is no longer active at remote (octet 2, bit 4).</li> </ul> |
|--|-----------------------------------------------------------------------------------------------------------------------------------------------------------------------------------------------------------------------------------------------------------------------------------------------|

#### 5.1.1.2.3 **Bi-directional Loopback at Remote (If supported by both ends)**

##### A) Activate Bi-directional Loopback at Remote

|                        |                                                                                                                                                                                                                                                                                                                                                                                                                                                                                                                                                                                                                              |
|------------------------|------------------------------------------------------------------------------------------------------------------------------------------------------------------------------------------------------------------------------------------------------------------------------------------------------------------------------------------------------------------------------------------------------------------------------------------------------------------------------------------------------------------------------------------------------------------------------------------------------------------------------|
| Test Case Identifier   | SH-5112-30                                                                                                                                                                                                                                                                                                                                                                                                                                                                                                                                                                                                                   |
| Test Case Name         | Activate Bi-directional Loopback at Remote                                                                                                                                                                                                                                                                                                                                                                                                                                                                                                                                                                                   |
| Test Purpose           | Test correct operation if supported                                                                                                                                                                                                                                                                                                                                                                                                                                                                                                                                                                                          |
| Standard Requirement   |                                                                                                                                                                                                                                                                                                                                                                                                                                                                                                                                                                                                                              |
| Additional Information | Note that multiple loopbacks may be activated one direction at a time using separate messages                                                                                                                                                                                                                                                                                                                                                                                                                                                                                                                                |
| Procedure              | Activate bi-directional loopback at remote from CO unit.                                                                                                                                                                                                                                                                                                                                                                                                                                                                                                                                                                     |
| Expected Results       | <ul style="list-style-type: none"> <li>• Verify control for initiate loopback toward the network and customer (Octet 2, bits 2 &amp; 3) are set in element loopback message addressed to STU-R.</li> <li>• Verify error free payload data looped back towards both network and customer</li> <li>• Verify maintenance status message from remote indicates both the network and customer Loopbacks are active at remote (octet 2, bit 3 and 4)</li> <li>• If the remote cannot support multiple loopback requests, it shall respond with a maintenance status message that indicates its current active loopback.</li> </ul> |

##### B) Deactivate Bi-directional Loopback at Remote

Test both methods of deactivation

|                        |                                                                                                                                                       |
|------------------------|-------------------------------------------------------------------------------------------------------------------------------------------------------|
| Test Case Identifier   | SH-5112-31                                                                                                                                            |
| Test Case Name         | Deactivate Bi-directional Loopback at Remote                                                                                                          |
| Test Purpose           | Test for correct operation if supported                                                                                                               |
| Standard Requirement   |                                                                                                                                                       |
| Additional Information |                                                                                                                                                       |
| Procedure              | Deactivate bi-directional loopbacks at remote from CO unit user interface terminating loopback toward customer and network in system loopback message |
| Expected Results       | <ul style="list-style-type: none"> <li>• Verify control for terminate loopback toward the</li> </ul>                                                  |

|  |                                                                                                                                                                                                                                                                                                                                                                                                                                                                                                                                             |
|--|---------------------------------------------------------------------------------------------------------------------------------------------------------------------------------------------------------------------------------------------------------------------------------------------------------------------------------------------------------------------------------------------------------------------------------------------------------------------------------------------------------------------------------------------|
|  | <p>network and customer (Octet 2, bits 0 &amp; 1) are set in element loopback message.</p> <ul style="list-style-type: none"> <li>• Verify element loopback command destination address is only to STU-R</li> <li>• Verify loopbacks are dropped and data path restored.</li> <li>• Verify maintenance status message from remote to CO in response to status request message (msg id 11) immediately after looping down indicates both the network and customer loopbacks are no longer active at remote (octet 2, bit 3 and 4)</li> </ul> |
|--|---------------------------------------------------------------------------------------------------------------------------------------------------------------------------------------------------------------------------------------------------------------------------------------------------------------------------------------------------------------------------------------------------------------------------------------------------------------------------------------------------------------------------------------------|

|                        |                                                                                                                                                                                                                                                                                                                                                                                                                                                                                                                                                                 |
|------------------------|-----------------------------------------------------------------------------------------------------------------------------------------------------------------------------------------------------------------------------------------------------------------------------------------------------------------------------------------------------------------------------------------------------------------------------------------------------------------------------------------------------------------------------------------------------------------|
| Test Case Identifier   | SH-5112-32                                                                                                                                                                                                                                                                                                                                                                                                                                                                                                                                                      |
| Test Case Name         | Deactivate Bi-directional Loopback at Remote                                                                                                                                                                                                                                                                                                                                                                                                                                                                                                                    |
| Test Purpose           | Test for correct operation if supported                                                                                                                                                                                                                                                                                                                                                                                                                                                                                                                         |
| Standard Requirement   |                                                                                                                                                                                                                                                                                                                                                                                                                                                                                                                                                                 |
| Additional Information |                                                                                                                                                                                                                                                                                                                                                                                                                                                                                                                                                                 |
| Procedure              | Deactivate loopback at CO from remote unit User Interface using clear all maintenance states in element loopback message.                                                                                                                                                                                                                                                                                                                                                                                                                                       |
| Expected Results       | <ul style="list-style-type: none"> <li>• Verify control for clear all maintenance states (Octet 2 bit 6) is set in element loopback message.</li> <li>• Verify element loopback command destination address is only to STU-R</li> <li>• Verify loopbacks are dropped and data path restored.</li> <li>• Verify maintenance status message from remote to CO in response to status request message (msg id 11) immediately after looping down indicates both the network and customer loopbacks are no longer active at remote (octet 2, bit 3 and 4)</li> </ul> |

#### 5.1.1.2.4 Special Loopback at Remote (if supported)

##### A) **Activate Special Loopback at Remote to Network**

|                      |                                                    |
|----------------------|----------------------------------------------------|
| Test Case Identifier | SH-5112-40                                         |
| Test Case Name       | Activate Special Loopback at Remote to Network     |
| Test Purpose         | Test for correct operation if supported            |
| Standard Requirement |                                                    |
| Procedure            | Activate special loopback to network from CO unit. |

|                  |                                                                                                                                                                                                                                                                                                                                                                                                           |
|------------------|-----------------------------------------------------------------------------------------------------------------------------------------------------------------------------------------------------------------------------------------------------------------------------------------------------------------------------------------------------------------------------------------------------------|
| Expected Results | <ul style="list-style-type: none"> <li>• Verify control for special remote loopback (Octet 2, bit 5) is set in element loopback message.</li> <li>• Verify error free payload data is looped back towards network</li> <li>• Verify maintenance status message from remote in response to status request message (msg id 11) indicates a special loopback is active at remote (octet 2, bit 5)</li> </ul> |
|------------------|-----------------------------------------------------------------------------------------------------------------------------------------------------------------------------------------------------------------------------------------------------------------------------------------------------------------------------------------------------------------------------------------------------------|

### B) Deactivate Special Loopback Remote to Network

Test both methods of deactivation

|                      |                                                                                                                                                                                                                                                                                                                            |
|----------------------|----------------------------------------------------------------------------------------------------------------------------------------------------------------------------------------------------------------------------------------------------------------------------------------------------------------------------|
| Test Case Identifier | SH-5112-41                                                                                                                                                                                                                                                                                                                 |
| Test Case Name       | Deactivate Special Loopback Remote to Network                                                                                                                                                                                                                                                                              |
| Test Purpose         | Test for correct operation                                                                                                                                                                                                                                                                                                 |
| Standard Requirement |                                                                                                                                                                                                                                                                                                                            |
| Procedure            | Deactivate special loopback at remote to network from CO unit using terminate special loopback (octet 2 bit4) in element loopback message.                                                                                                                                                                                 |
| Expected Results     | <ul style="list-style-type: none"> <li>• Verify loopback dropped and data path restored.</li> <li>• Verify maintenance status message from remote in response to status request message (msg id 11) immediately after looping down indicates a network loopback is no longer active at remote (octet 2, bit 4).</li> </ul> |

|                      |                                                                                                                                                                                                                                                                                                                            |
|----------------------|----------------------------------------------------------------------------------------------------------------------------------------------------------------------------------------------------------------------------------------------------------------------------------------------------------------------------|
| Test Case Identifier | SH-5112-42                                                                                                                                                                                                                                                                                                                 |
| Test Case Name       | Deactivate Special Loopback Remote to Network                                                                                                                                                                                                                                                                              |
| Test Purpose         | Test for correct operation                                                                                                                                                                                                                                                                                                 |
| Standard Requirement |                                                                                                                                                                                                                                                                                                                            |
| Procedure            | Deactivate loopback at remote to network from CO unit using clear all maintenance states (octet 2 bit 6) in element loopback message.                                                                                                                                                                                      |
| Expected Results     | <ul style="list-style-type: none"> <li>• Verify loopback dropped and data path restored.</li> <li>• Verify maintenance status message from remote in response to status request message (msg id 11) immediately after looping down indicates a network loopback is no longer active at remote (octet 2, bit 4).</li> </ul> |

**5.1.1.3 CO Control Mode: CO Loopback: Remote Display**

This test is for the STU-C that processes CO Loopbacks issued at the CO unit user interface locally with no remote unit involvement.

**5.1.1.3.1 Network Loopback at CO****A) Activate Network Loopback at CO**

|                      |                                                                                                                                                                                                                                 |
|----------------------|---------------------------------------------------------------------------------------------------------------------------------------------------------------------------------------------------------------------------------|
| Test Case Identifier | SH-5113-10                                                                                                                                                                                                                      |
| Test Case Name       | Activate Network Loopback at CO                                                                                                                                                                                                 |
| Test Purpose         | Test for correct operation                                                                                                                                                                                                      |
| Standard Requirement |                                                                                                                                                                                                                                 |
| Procedure            | Activate network loopback at CO from the CO unit user interface.                                                                                                                                                                |
| Expected Results     | <ul style="list-style-type: none"> <li>• Verify error free payload is looped back towards network</li> <li>• Verify maintenance status message from CO indicates a network loopback is active at CO (Octet 2, Bit 3)</li> </ul> |

**B) Deactivate Network Loopback at CO**

|                      |                                                                                                                                                                                                                                                                                              |
|----------------------|----------------------------------------------------------------------------------------------------------------------------------------------------------------------------------------------------------------------------------------------------------------------------------------------|
| Test Case Identifier | SH-5113-11                                                                                                                                                                                                                                                                                   |
| Test Case Name       | Deactivate Network Loopback at CO                                                                                                                                                                                                                                                            |
| Test Purpose         | Verify correct operation                                                                                                                                                                                                                                                                     |
| Standard Requirement |                                                                                                                                                                                                                                                                                              |
| Procedure            | Deactivate network loopback at CO from CO unit user interface.                                                                                                                                                                                                                               |
| Expected Results     | <ul style="list-style-type: none"> <li>• Verify loopback dropped and datapath restored</li> <li>• Verify maintenance status message from CO to remote in response to status request message (Msg id 11) indicates the network loopback is no longer active at CO (octet2, bit 3).</li> </ul> |

**5.1.1.3.2 Customer Loopback at CO****A) Activate Customer Loopback at CO**

|                      |                                  |
|----------------------|----------------------------------|
| Test Case Identifier | SH-5113-20                       |
| Test Case Name       | Activate Customer Loopback at CO |

|                      |                                                                                                                                                                                                                                   |
|----------------------|-----------------------------------------------------------------------------------------------------------------------------------------------------------------------------------------------------------------------------------|
| Test Purpose         | Test correct operation                                                                                                                                                                                                            |
| Standard Requirement |                                                                                                                                                                                                                                   |
| Procedure            | <ul style="list-style-type: none"> <li>• Activate Customer loopback at CO from the CO unit user interface.</li> </ul>                                                                                                             |
| Expected Results     | <ul style="list-style-type: none"> <li>• Verify error free payload is looped back towards customer</li> <li>• Verify maintenance status message from CO indicates a customer loopback is active at CO (Octet 2, Bit 4)</li> </ul> |

### B) Deactivate Customer Loopback at CO

|                      |                                                                                                                                                                                                                                                                                               |
|----------------------|-----------------------------------------------------------------------------------------------------------------------------------------------------------------------------------------------------------------------------------------------------------------------------------------------|
| Test Case Identifier | SH-5113-21                                                                                                                                                                                                                                                                                    |
| Test Case Name       | Deactivate Customer Loopback at CO                                                                                                                                                                                                                                                            |
| Test Purpose         | Verify correct operation                                                                                                                                                                                                                                                                      |
| Standard Requirement |                                                                                                                                                                                                                                                                                               |
| Procedure            | Deactivate network loopback at CO from CO unit user interface.                                                                                                                                                                                                                                |
| Expected Results     | <ul style="list-style-type: none"> <li>• Verify loopback dropped and datapath restored</li> <li>• Verify maintenance status message from CO to remote in response to status request message (Msg id 11) indicates the customer loopback is no longer active at CO (octet2, bit 4).</li> </ul> |

#### 5.1.1.3.3 Bi-Directional Loopback at CO

### A) Activate Bi-directional Loopback at CO

|                      |                                                                                                                                                                                                                                                                              |
|----------------------|------------------------------------------------------------------------------------------------------------------------------------------------------------------------------------------------------------------------------------------------------------------------------|
| Test Case Identifier | SH-5113-30                                                                                                                                                                                                                                                                   |
| Test Case Name       | Activate Bi-directional Loopback at CO                                                                                                                                                                                                                                       |
| Test Purpose         | Test correct operation                                                                                                                                                                                                                                                       |
| Standard Requirement |                                                                                                                                                                                                                                                                              |
| Procedure            | Activate bi-directional loopback at CO from the CO unit user interface.                                                                                                                                                                                                      |
| Expected Results     | <ul style="list-style-type: none"> <li>• Verify error free payload is looped back towards network and customer</li> <li>• Verify maintenance status message sent from CO indicates both a network and customer loopback are active at CO (Octet 2, Bits 3 &amp;4)</li> </ul> |

### B) Deactivate Bi-directional Loop back at CO

|                      |                                                                                                                                                                                                                                                                                                              |
|----------------------|--------------------------------------------------------------------------------------------------------------------------------------------------------------------------------------------------------------------------------------------------------------------------------------------------------------|
| Test Case Identifier | SH-5113-31                                                                                                                                                                                                                                                                                                   |
| Test Case Name       | Deactivate Bi-directional Loop back at CO                                                                                                                                                                                                                                                                    |
| Test Purpose         | Test correct operation                                                                                                                                                                                                                                                                                       |
| Standard Requirement |                                                                                                                                                                                                                                                                                                              |
| Procedure            | Deactivate network loop back at CO from CO unit user interface.                                                                                                                                                                                                                                              |
| Expected Results     | <ul style="list-style-type: none"> <li>• Verify loop backs are dropped and data path restored</li> <li>• Verify maintenance status message from CO to remote in response to status request message (Msg id 11) indicates that both loop backs are no longer active at CO (octet2, bits 3 &amp; 4)</li> </ul> |

### 5.1.2 Remote Control Mode

The following tests are applicable when the user is controlling all loopbacks at the STU-R. Support of loopback initiated at the STU-R is optional.

#### 5.1.2.1 Remote Control Mode: System Loop back Message (Msg id 9)

This set of tests is applicable with any STU-C when the STU-R unit implements a System Loop back Message control to activate loop backs.

##### 5.1.2.1.1 Network Loop back at CO

Activate Network Loop back at Remote

|                      |                                                                                                                                                                                                                                                                                                                                                                                                                                                                       |
|----------------------|-----------------------------------------------------------------------------------------------------------------------------------------------------------------------------------------------------------------------------------------------------------------------------------------------------------------------------------------------------------------------------------------------------------------------------------------------------------------------|
| Test Case Identifier | SH-5121-10                                                                                                                                                                                                                                                                                                                                                                                                                                                            |
| Test Case Name       | Activate Network Loop back at Remote                                                                                                                                                                                                                                                                                                                                                                                                                                  |
| Test Purpose         | Test correct operation                                                                                                                                                                                                                                                                                                                                                                                                                                                |
| Standard Requirement |                                                                                                                                                                                                                                                                                                                                                                                                                                                                       |
| Procedure            | Activate network loop back at CO from Remote Unit user interface                                                                                                                                                                                                                                                                                                                                                                                                      |
| Expected Results     | <ul style="list-style-type: none"> <li>• Verify control for initiate loop back toward the network in command for STU-C (octet 2 bit 3) set in system loopback message</li> <li>• Verify error free payload data looped back towards network</li> <li>• Verify System Loopback command destination address to only STU-C (Destination Address =1)</li> <li>• Verify maintenance status message from CO to Remote in response to status request message (msg</li> </ul> |



|  |                                                                         |
|--|-------------------------------------------------------------------------|
|  | id 11) indicates a network loopback is active at remote (octet 2 bit 3) |
|--|-------------------------------------------------------------------------|

## Deactivate Network Loopback at CO

Test both methods of deactivation

|                      |                                                                                                                                                                                                                                                                                                                                                                                                                                                                                                                                                                          |
|----------------------|--------------------------------------------------------------------------------------------------------------------------------------------------------------------------------------------------------------------------------------------------------------------------------------------------------------------------------------------------------------------------------------------------------------------------------------------------------------------------------------------------------------------------------------------------------------------------|
| Test Case Identifier | SH-5121-11                                                                                                                                                                                                                                                                                                                                                                                                                                                                                                                                                               |
| Test Case Name       | Deactivate Network Loopback at CO                                                                                                                                                                                                                                                                                                                                                                                                                                                                                                                                        |
| Test Purpose         | Verify operation                                                                                                                                                                                                                                                                                                                                                                                                                                                                                                                                                         |
| Standard Requirement |                                                                                                                                                                                                                                                                                                                                                                                                                                                                                                                                                                          |
| Procedure            | Deactivate network loopback at CO from remote unit user interface. Use terminate loopback toward network in system loopback message.                                                                                                                                                                                                                                                                                                                                                                                                                                     |
| Expected Results     | <ul style="list-style-type: none"> <li>• Verify control for terminate loopback toward the network in command for STU-C (octet 2 bit 1) set in system loopback message.</li> <li>• Verify System Loopback command destination address to only STU-C (Destination Address=1)</li> <li>• Verify Loopback dropped and data path restored.</li> <li>• Verify maintenance status message from CO to remote in response to status request message (Msg id 11) immediately after looping down indicates a network loopback is no longer active at CO (octet 2, bit3).</li> </ul> |

|                      |                                                                                                                                                                                                                                                                                                                                                                                                                                                                                          |
|----------------------|------------------------------------------------------------------------------------------------------------------------------------------------------------------------------------------------------------------------------------------------------------------------------------------------------------------------------------------------------------------------------------------------------------------------------------------------------------------------------------------|
| Test Case Identifier | SH-5121-12                                                                                                                                                                                                                                                                                                                                                                                                                                                                               |
| Test Case Name       | Deactivate Network Loopback at CO                                                                                                                                                                                                                                                                                                                                                                                                                                                        |
| Test Purpose         | Verify operation                                                                                                                                                                                                                                                                                                                                                                                                                                                                         |
| Standard Requirement |                                                                                                                                                                                                                                                                                                                                                                                                                                                                                          |
| Procedure            | Deactivate network loopback at CO from remote unit user interface. Clear all maintenance states in system loop back message.                                                                                                                                                                                                                                                                                                                                                             |
| Expected Results     | <ul style="list-style-type: none"> <li>• Verify control for clear all maintenance states in command for STU-C (octet 2, bit 6) set in system loopback message.</li> <li>• Verify System Loopback command destination address to only STU-C (Destination Address=1)</li> <li>• Verify Loopback dropped and data path restored.</li> <li>• Verify maintenance status message from CO to remote in response to status request message (Msg id 11) immediately after looping down</li> </ul> |

|  |                                                                         |
|--|-------------------------------------------------------------------------|
|  | indicates a network loopback is no longer active at CO (octet 2, bit3). |
|--|-------------------------------------------------------------------------|

#### 5.1.2.1.2 Customer Loopback at CO

Activate Customer Loopback at CO

|                      |                                                                                                                                                                                                                                                                                                                                                                                                                                                                                                                                            |
|----------------------|--------------------------------------------------------------------------------------------------------------------------------------------------------------------------------------------------------------------------------------------------------------------------------------------------------------------------------------------------------------------------------------------------------------------------------------------------------------------------------------------------------------------------------------------|
| Test Case Identifier | SH-5121-20                                                                                                                                                                                                                                                                                                                                                                                                                                                                                                                                 |
| Test Case Name       | Activate Customer Loopback at CO                                                                                                                                                                                                                                                                                                                                                                                                                                                                                                           |
| Test Purpose         | Test correct operation                                                                                                                                                                                                                                                                                                                                                                                                                                                                                                                     |
| Standard Requirement |                                                                                                                                                                                                                                                                                                                                                                                                                                                                                                                                            |
| Procedure            | Activate customer loopback at CO from remote unit user interface                                                                                                                                                                                                                                                                                                                                                                                                                                                                           |
| Expected Results     | <ul style="list-style-type: none"> <li>• Verify control for initiate loopback toward the customer in command for STU-C (octet 2 bit 2) set in system loopback message</li> <li>• Verify error free payload data looped back towards customer</li> <li>• Verify System Loopback command destination address to only STU-C (Destination Address=1)</li> <li>• Verify maintenance status message from CO to remote in response to status request message (msg id 11) indicates a customer loopback is active at CO (octet 2 bit 4)</li> </ul> |

Deactivate Customer Loopback at Remote

Test both methods of deactivation

|                      |                                                                                                                                                                                                                                                                                                                                                                                                           |
|----------------------|-----------------------------------------------------------------------------------------------------------------------------------------------------------------------------------------------------------------------------------------------------------------------------------------------------------------------------------------------------------------------------------------------------------|
| Test Case Identifier | SH-5121-21                                                                                                                                                                                                                                                                                                                                                                                                |
| Test Case Name       | Deactivate Customer Loopback at Remote                                                                                                                                                                                                                                                                                                                                                                    |
| Test Purpose         | Test operation                                                                                                                                                                                                                                                                                                                                                                                            |
| Standard Requirement |                                                                                                                                                                                                                                                                                                                                                                                                           |
| Procedure            | Deactivate customer loopback at CO from CO from remote unit user interface using terminate loopback toward customer in system loopback message.                                                                                                                                                                                                                                                           |
| Expected Results     | <ul style="list-style-type: none"> <li>• Verify control for terminate loopback toward the customer in command for STU-C (octet 2 bit 0) set in system loopback message.</li> <li>• Verify loopback dropped and data path restores.</li> <li>• Verify System Loopback command destination address to only STU-C (Destination Address=1)</li> <li>• Verify maintenance status message from CO to</li> </ul> |

|  |                                                                                                                                                                      |
|--|----------------------------------------------------------------------------------------------------------------------------------------------------------------------|
|  | remote in response to status request message (Msg id 11) immediately after looping down indicates a customer loopback is no longer active at remote (octet 2, bit4). |
|--|----------------------------------------------------------------------------------------------------------------------------------------------------------------------|

|                      |                                                                                                                                                                                                                                                                                                                                                                                                                                                                                                                                                                     |
|----------------------|---------------------------------------------------------------------------------------------------------------------------------------------------------------------------------------------------------------------------------------------------------------------------------------------------------------------------------------------------------------------------------------------------------------------------------------------------------------------------------------------------------------------------------------------------------------------|
| Test Case Identifier | SH-5121-22                                                                                                                                                                                                                                                                                                                                                                                                                                                                                                                                                          |
| Test Case Name       | Deactivate Customer Loopback at Remote                                                                                                                                                                                                                                                                                                                                                                                                                                                                                                                              |
| Test Purpose         | Test operation                                                                                                                                                                                                                                                                                                                                                                                                                                                                                                                                                      |
| Standard Requirement |                                                                                                                                                                                                                                                                                                                                                                                                                                                                                                                                                                     |
| Procedure            | Deactivate customer loopback at CO from remote unit user interface using clear all maintenance states in system loop back message.                                                                                                                                                                                                                                                                                                                                                                                                                                  |
| Expected Results     | <ul style="list-style-type: none"> <li>• Verify control for clear all maintenance states in command for STU-C(octet 2, bit 6) set in system loopback message</li> <li>• Verify loopback dropped and data path restores.</li> <li>• Verify System Loopback command destination address to only STU-C (Destination Address=1)</li> <li>• Verify maintenance status message from CO to remote in response to status request message (Msg id 11) immediately after looping down indicates a customer loopback is no longer active at remote (octet 2, bit4).</li> </ul> |

#### 5.1.2.1.3 **Bi-directional Loopback at CO (if supported by both ends)**

Activate Bi-directional Loopback at CO

|                        |                                                                                                                                                                                                                                                                                                                                                        |
|------------------------|--------------------------------------------------------------------------------------------------------------------------------------------------------------------------------------------------------------------------------------------------------------------------------------------------------------------------------------------------------|
| Test Case Identifier   | SH-5121-30                                                                                                                                                                                                                                                                                                                                             |
| Test Case Name         | Activate Bi-directional Loopback at CO                                                                                                                                                                                                                                                                                                                 |
| Test Purpose           | Test correct operation if supported                                                                                                                                                                                                                                                                                                                    |
| Standard Requirement   |                                                                                                                                                                                                                                                                                                                                                        |
| Additional Information | (Note: may have to activate one direction at a time)                                                                                                                                                                                                                                                                                                   |
| Procedure              | Activate bi-directional loopback at CO from remote unit user interface                                                                                                                                                                                                                                                                                 |
| Expected Results       | <ul style="list-style-type: none"> <li>• Verify control for initiate loopback towards the network and customer in command for STU-C (octet 2 bits 2 &amp; 3) are set in system loopback message</li> <li>• Verify error free payload data looped back towards network and customer</li> <li>• Verify maintenance status messages from CO in</li> </ul> |

|  |                                                                                                                                                                                                                                                                                                                                            |
|--|--------------------------------------------------------------------------------------------------------------------------------------------------------------------------------------------------------------------------------------------------------------------------------------------------------------------------------------------|
|  | <p>response to status request message (msg id 11) indicates a bi-directional loopback is active at CO (octet 2 bits 3 &amp; 4)</p> <ul style="list-style-type: none"> <li>• If the CO cannot support multiple loopback requests, it shall respond with a maintenance status message that indicates its current active loopback.</li> </ul> |
|--|--------------------------------------------------------------------------------------------------------------------------------------------------------------------------------------------------------------------------------------------------------------------------------------------------------------------------------------------|

### B) Deactivate Bi-directional Loopback at CO

Test both methods of deactivation

|                        |                                                                                                                                                                                                                                                                                                                                                                                                                                                                                                                 |
|------------------------|-----------------------------------------------------------------------------------------------------------------------------------------------------------------------------------------------------------------------------------------------------------------------------------------------------------------------------------------------------------------------------------------------------------------------------------------------------------------------------------------------------------------|
| Test Case Identifier   | SH-5121-31                                                                                                                                                                                                                                                                                                                                                                                                                                                                                                      |
| Test Case Name         | Deactivate Bi-directional Loopback at CO                                                                                                                                                                                                                                                                                                                                                                                                                                                                        |
| Test Purpose           | Verify correct operation if supported                                                                                                                                                                                                                                                                                                                                                                                                                                                                           |
| Standard Requirement   |                                                                                                                                                                                                                                                                                                                                                                                                                                                                                                                 |
| Additional Information | (Note: may have to activate one direction at a time)                                                                                                                                                                                                                                                                                                                                                                                                                                                            |
| Procedure              | Deactivate bi-directional loopback at CO from remote unit user interface using terminate loopback toward network and customer in system loopback message.                                                                                                                                                                                                                                                                                                                                                       |
| Expected Results       | <ul style="list-style-type: none"> <li>• Verify control for terminate loopback toward the network and customer in command for STU-C (octet 2 bits 0 &amp; 1) set in system loopback message.</li> <li>• Verify loopback dropped and data path restores.</li> <li>• Verify maintenance status message from CO to remote in response to status request message (Msg id 11) immediately after looping down indicates the network and customer loopbacks are no longer active at remote (octet 2, bit4).</li> </ul> |

|                        |                                                                                                                                                                                                                                                                                                                                                  |
|------------------------|--------------------------------------------------------------------------------------------------------------------------------------------------------------------------------------------------------------------------------------------------------------------------------------------------------------------------------------------------|
| Test Case Identifier   | SH-5121-32                                                                                                                                                                                                                                                                                                                                       |
| Test Case Name         | Deactivate Bi-directional Loopback at CO                                                                                                                                                                                                                                                                                                         |
| Test Purpose           | Verify correct operation if supported                                                                                                                                                                                                                                                                                                            |
| Standard Requirement   |                                                                                                                                                                                                                                                                                                                                                  |
| Additional Information | (Note: may have to activate one direction at a time)                                                                                                                                                                                                                                                                                             |
| Procedure              | Deactivate bi-directional loopback at CO from remote unit user interface using clear all maintenance states in system loop back message.                                                                                                                                                                                                         |
| Expected Results       | <ul style="list-style-type: none"> <li>• Verify control for clear all maintenance states in command for STU-C (octet 2, bit 6) set in system loopback message</li> <li>• Verify loopback dropped and data path restores.</li> <li>• Verify maintenance status message from CO to remote in response to status request message (Msg id</li> </ul> |

|  |                                                                                                                                 |
|--|---------------------------------------------------------------------------------------------------------------------------------|
|  | 11) immediately after looping down indicates the network and customer loopbacks are no longer active at remote (octet 2, bit4). |
|--|---------------------------------------------------------------------------------------------------------------------------------|

#### 5.1.2.1.4 Network Loopback at Remote using CO control

##### A) **Activate Network Loopback at Remote**

|                      |                                                                                                                                                                                                                                                                                                                                                                                                                                                                                                                                                                                                                                                                                                                                                                                                                                                                                                                                                                                                                                                                                                                                        |
|----------------------|----------------------------------------------------------------------------------------------------------------------------------------------------------------------------------------------------------------------------------------------------------------------------------------------------------------------------------------------------------------------------------------------------------------------------------------------------------------------------------------------------------------------------------------------------------------------------------------------------------------------------------------------------------------------------------------------------------------------------------------------------------------------------------------------------------------------------------------------------------------------------------------------------------------------------------------------------------------------------------------------------------------------------------------------------------------------------------------------------------------------------------------|
| Test Case Identifier | SH-5121-40                                                                                                                                                                                                                                                                                                                                                                                                                                                                                                                                                                                                                                                                                                                                                                                                                                                                                                                                                                                                                                                                                                                             |
| Test Case Name       | Activate Network Loopback at Remote                                                                                                                                                                                                                                                                                                                                                                                                                                                                                                                                                                                                                                                                                                                                                                                                                                                                                                                                                                                                                                                                                                    |
| Test Purpose         | Test correct operation                                                                                                                                                                                                                                                                                                                                                                                                                                                                                                                                                                                                                                                                                                                                                                                                                                                                                                                                                                                                                                                                                                                 |
| Standard Requirement |                                                                                                                                                                                                                                                                                                                                                                                                                                                                                                                                                                                                                                                                                                                                                                                                                                                                                                                                                                                                                                                                                                                                        |
| Procedure            | Activate network loopback at Remote from remote unit user interface                                                                                                                                                                                                                                                                                                                                                                                                                                                                                                                                                                                                                                                                                                                                                                                                                                                                                                                                                                                                                                                                    |
| Expected Results     | <ul style="list-style-type: none"> <li>• Verify control for initiate loopback towards the network in command for STU-R (octet 3 bits 3) are set in system loopback message</li> <li>• Verify System Loopback command destination address to only STU-C (Destination Address=1)</li> <li>• Verify CO sends loopback control to STU-R by either of the following two methods: <ul style="list-style-type: none"> <li>➤ Sending a system Maintenance broadcast message indicating only initiate loopback toward the network in command for STU-R (octet 3, bit 3) set in system loopback message.</li> </ul> </li> </ul> <p style="text-align: center;">OR</p> <ul style="list-style-type: none"> <li>➤ Sending an element loopback message to STU-R with the initiate loopback toward the network command (octet 2, bit 3)</li> </ul> <ul style="list-style-type: none"> <li>• Verify error free payload data looped back towards network</li> <li>• Verify maintenance status message from remote to CO in response to status request message (msg id 11) indicates a customer loopback is active at remote (octet 2, bit 3)</li> </ul> |

**B) Deactivate Network Loopback at Remote**

|                      |                                                                                                                                                                                                                                                                                                                                                                                                                                                                                                                                                                                                                                                                                                                                                                                                                                                                                                                                                                                                                                                                                                                                                                                                                                                                                                          |
|----------------------|----------------------------------------------------------------------------------------------------------------------------------------------------------------------------------------------------------------------------------------------------------------------------------------------------------------------------------------------------------------------------------------------------------------------------------------------------------------------------------------------------------------------------------------------------------------------------------------------------------------------------------------------------------------------------------------------------------------------------------------------------------------------------------------------------------------------------------------------------------------------------------------------------------------------------------------------------------------------------------------------------------------------------------------------------------------------------------------------------------------------------------------------------------------------------------------------------------------------------------------------------------------------------------------------------------|
| Test Case Identifier | SH-5121-41                                                                                                                                                                                                                                                                                                                                                                                                                                                                                                                                                                                                                                                                                                                                                                                                                                                                                                                                                                                                                                                                                                                                                                                                                                                                                               |
| Test Case Name       | Deactivate Network Loopback at Remote                                                                                                                                                                                                                                                                                                                                                                                                                                                                                                                                                                                                                                                                                                                                                                                                                                                                                                                                                                                                                                                                                                                                                                                                                                                                    |
| Test Purpose         | Verify correct operation                                                                                                                                                                                                                                                                                                                                                                                                                                                                                                                                                                                                                                                                                                                                                                                                                                                                                                                                                                                                                                                                                                                                                                                                                                                                                 |
| Standard Requirement |                                                                                                                                                                                                                                                                                                                                                                                                                                                                                                                                                                                                                                                                                                                                                                                                                                                                                                                                                                                                                                                                                                                                                                                                                                                                                                          |
| Procedure            | Deactivate network loopback at remote from remote unit user interface.                                                                                                                                                                                                                                                                                                                                                                                                                                                                                                                                                                                                                                                                                                                                                                                                                                                                                                                                                                                                                                                                                                                                                                                                                                   |
| Expected Results     | <ul style="list-style-type: none"> <li>• Verify remote sends terminate loopback command set in command for STU-R set in system loopback command sent to CO. Either of the following. <ul style="list-style-type: none"> <li>A. Control for only terminate loopback toward the network in command for STU-R (octet 3, bit 1) set in system loopback message.</li> </ul> </li> <li>OR</li> <li>B. Control for only clear all maintenance states in command for STU-R (octet 3 bit 6) set in system loopback message.</li> </ul> <ul style="list-style-type: none"> <li>• Verify System Loopback command destination address to only STU-C (Destination Address=1)</li> <li>• Verify CO sends loopback control to STU-R by any of the following methods (all methods should work equivalently): <ul style="list-style-type: none"> <li>➤ Sending a system Maintenance broadcast message indicating only terminate loopback toward the network in command for STU-R (octet 3 bit 1) set in system loopback message.</li> </ul> </li> <li>OR</li> <li>➤ Sending a system Maintenance broadcast message indicating only control for clear all maintenance states in command for STU-R (octet 3 bit 6) set in system loopback message.</li> <li>OR</li> <li>➤ Sending an element loopback message to</li> </ul> |

|  |                                                                                                                                                                                                                                                                                                                                                                                                                                                                                                                                                                                                           |
|--|-----------------------------------------------------------------------------------------------------------------------------------------------------------------------------------------------------------------------------------------------------------------------------------------------------------------------------------------------------------------------------------------------------------------------------------------------------------------------------------------------------------------------------------------------------------------------------------------------------------|
|  | <p>STU-R with the terminate loopback toward the network command (octet 2 bit 6)</p> <p>OR</p> <ul style="list-style-type: none"> <li>➤ Sending an element loopback message to STU-R with only control for clear all maintenance states in command (octet 2 bit6)</li> </ul> <ul style="list-style-type: none"> <li>• Verify loopback dropped and data path restored.</li> <li>• Verify maintenance status message from remote to CO in response to status request message (msg id 11) immediately after looping down indicates network loopback is no longer active at remote (octet 2 bit 3).</li> </ul> |
|--|-----------------------------------------------------------------------------------------------------------------------------------------------------------------------------------------------------------------------------------------------------------------------------------------------------------------------------------------------------------------------------------------------------------------------------------------------------------------------------------------------------------------------------------------------------------------------------------------------------------|

**5.1.2.1.5 Customer Loopback at Remote using CO control**

**A) Activate Customer Loopback at Remote**

|                      |                                                                                                                                                                                                                                                                                                                                                                                                                                                                                                                                                                                                                                                                                                                                        |
|----------------------|----------------------------------------------------------------------------------------------------------------------------------------------------------------------------------------------------------------------------------------------------------------------------------------------------------------------------------------------------------------------------------------------------------------------------------------------------------------------------------------------------------------------------------------------------------------------------------------------------------------------------------------------------------------------------------------------------------------------------------------|
| Test Case Identifier | SH-5121-50                                                                                                                                                                                                                                                                                                                                                                                                                                                                                                                                                                                                                                                                                                                             |
| Test Case Name       | Activate Customer Loopback at Remote                                                                                                                                                                                                                                                                                                                                                                                                                                                                                                                                                                                                                                                                                                   |
| Test Purpose         | Test correct operation                                                                                                                                                                                                                                                                                                                                                                                                                                                                                                                                                                                                                                                                                                                 |
| Standard Requirement |                                                                                                                                                                                                                                                                                                                                                                                                                                                                                                                                                                                                                                                                                                                                        |
| Procedure            | Activate network loopback at Remote from remote unit user interface                                                                                                                                                                                                                                                                                                                                                                                                                                                                                                                                                                                                                                                                    |
| Expected Results     | <ul style="list-style-type: none"> <li>• Verify o control for initiate loopback towards the customer in command for STU-R (octet 3 bits 2) set in system loopback message</li> <li>• Verify System Loopback command destination address to only STU-C (Destination Address=1)</li> <li>• Verify CO sends loopback control to STU-R by either of the following two methods: <ul style="list-style-type: none"> <li>A. Sending a system Maintenance broadcast message indicating only initiate loopback toward the customer in command for STU-R (octet 3, bit 2) set in system loopback message.</li> </ul> </li> </ul> <p>OR</p> <p>B. Sending an element loopback message to STU-R with the initiate loopback toward the customer</p> |

|  |                                                                                                                                                                                                                                                                                                                                     |
|--|-------------------------------------------------------------------------------------------------------------------------------------------------------------------------------------------------------------------------------------------------------------------------------------------------------------------------------------|
|  | <p>command (octet 2, bit 2)</p> <ul style="list-style-type: none"> <li>• Verify error free payload data looped back towards customer</li> <li>• Verify maintenance status message from remote to CO in response to status request message (msg id 11) indicates a customer loopback is active at remote (octet 2, bit 4)</li> </ul> |
|--|-------------------------------------------------------------------------------------------------------------------------------------------------------------------------------------------------------------------------------------------------------------------------------------------------------------------------------------|

## B) Deactivate Customer Loopback at Remote

|                      |                                                                                                                                                                                                                                                                                                                                                                                                                                                                                                                                                                                                                                                                                                                                                                                                                                                                                                                                                                                                                                                       |
|----------------------|-------------------------------------------------------------------------------------------------------------------------------------------------------------------------------------------------------------------------------------------------------------------------------------------------------------------------------------------------------------------------------------------------------------------------------------------------------------------------------------------------------------------------------------------------------------------------------------------------------------------------------------------------------------------------------------------------------------------------------------------------------------------------------------------------------------------------------------------------------------------------------------------------------------------------------------------------------------------------------------------------------------------------------------------------------|
| Test Case Identifier | SH-5121-51                                                                                                                                                                                                                                                                                                                                                                                                                                                                                                                                                                                                                                                                                                                                                                                                                                                                                                                                                                                                                                            |
| Test Case Name       | Deactivate Customer Loopback at Remote                                                                                                                                                                                                                                                                                                                                                                                                                                                                                                                                                                                                                                                                                                                                                                                                                                                                                                                                                                                                                |
| Test Purpose         | Verify correct operation                                                                                                                                                                                                                                                                                                                                                                                                                                                                                                                                                                                                                                                                                                                                                                                                                                                                                                                                                                                                                              |
| Standard Requirement |                                                                                                                                                                                                                                                                                                                                                                                                                                                                                                                                                                                                                                                                                                                                                                                                                                                                                                                                                                                                                                                       |
| Procedure            | Deactivate customer loopback at CO from remote unit user interface.                                                                                                                                                                                                                                                                                                                                                                                                                                                                                                                                                                                                                                                                                                                                                                                                                                                                                                                                                                                   |
| Expected Results     | <ul style="list-style-type: none"> <li>• Verify remote sends terminate loopback command set in command for STU-R set in system loopback command sent to CO. Either of the following. <ul style="list-style-type: none"> <li>A. Control for only terminate loopback toward the network in command for STU-R (octet 3, bit 0) set in system loopback message.</li> </ul> </li> <li>OR</li> <li>B. Control for only clear all maintenance states in command for STU-R (octet 3 bit 6) set in system loopback message.</li> </ul> <ul style="list-style-type: none"> <li>• Verify System Loopback command destination address to only STU-C (Destination Address=1)</li> <li>• Verify CO sends loopback control to (HLXR) by any of the following methods (all methods should work equivalently): <ul style="list-style-type: none"> <li>A. Sending a system Maintenance broadcast message indicating only terminate loopback toward the customer in command for STU-R (octet 3 bit 0) set in system loopback message.</li> </ul> </li> <li>OR</li> </ul> |



|  |                                                                                                                                                                                                                                                                                                                                                                                                                                                                                                                                                                                                                                                                                                                                                                                                           |
|--|-----------------------------------------------------------------------------------------------------------------------------------------------------------------------------------------------------------------------------------------------------------------------------------------------------------------------------------------------------------------------------------------------------------------------------------------------------------------------------------------------------------------------------------------------------------------------------------------------------------------------------------------------------------------------------------------------------------------------------------------------------------------------------------------------------------|
|  | <p>B. Sending a system Maintenance broadcast message indicating only control for clear all maintenance states in command for STU-R (octet 3 bit 6) set in system loopback message.</p> <p>OR</p> <p>C. Sending an element loopback message to STU-R with the terminate loopback toward the customer command (octet 2 bit 0)</p> <p>OR</p> <p>D. Sending an element loopback message to STU-R with only control for all maintenance states in command (octet 2 bit 6)</p> <ul style="list-style-type: none"> <li>• Verify loopback dropped and data path restored.</li> <li>• Verify maintenance status message from remote to CO in response to status request message (msg id 11) immediately after looping down indicates a customer loopback is no longer active at remote (octet 2 bit 4).</li> </ul> |
|--|-----------------------------------------------------------------------------------------------------------------------------------------------------------------------------------------------------------------------------------------------------------------------------------------------------------------------------------------------------------------------------------------------------------------------------------------------------------------------------------------------------------------------------------------------------------------------------------------------------------------------------------------------------------------------------------------------------------------------------------------------------------------------------------------------------------|

**5.1.2.1.6 Bi-directional Loopback at Remote using CO control (if supported by both ends)**

**A) Activate Bi-directional Loopback at Remote**

|                      |                                                                                                                                                                                                                                                                                                                                                                                                                                                         |
|----------------------|---------------------------------------------------------------------------------------------------------------------------------------------------------------------------------------------------------------------------------------------------------------------------------------------------------------------------------------------------------------------------------------------------------------------------------------------------------|
| Test Case Identifier | SH-5121-60                                                                                                                                                                                                                                                                                                                                                                                                                                              |
| Test Case Name       | Activate Bi-directional Loopback at Remote                                                                                                                                                                                                                                                                                                                                                                                                              |
| Test Purpose         | Test for correct operation                                                                                                                                                                                                                                                                                                                                                                                                                              |
| Standard Requirement |                                                                                                                                                                                                                                                                                                                                                                                                                                                         |
| Procedure            | Activate bi-directional loopback at remote from remote unit user interface.                                                                                                                                                                                                                                                                                                                                                                             |
| Expected Results     | <ul style="list-style-type: none"> <li>• Verify control for initiate loopback towards the network and customer in command for STU-R (octet 3 bits 2&amp;3) set in system loopback message</li> <li>• Verify System Loopback command destination address to only STU-C (Destination Address=1)</li> <li>• Verify CO sends loopback control to (HLXR) by either of the following two methods:</li> </ul> <p>A. Sending a system Maintenance broadcast</p> |

|  |                                                                                                                                                                                                                                                                                                                                                                                                                                                                                                                                                                                                                                                                                                                                                                                                                                         |
|--|-----------------------------------------------------------------------------------------------------------------------------------------------------------------------------------------------------------------------------------------------------------------------------------------------------------------------------------------------------------------------------------------------------------------------------------------------------------------------------------------------------------------------------------------------------------------------------------------------------------------------------------------------------------------------------------------------------------------------------------------------------------------------------------------------------------------------------------------|
|  | <p>message indicating only Initiate loopback toward the network and customer in command for STU-R (octet 3, bit 2&amp;3) set in system loopback message.</p> <p>OR</p> <p>B. Sending an element loopback message to STU-R with the initiate loopback toward the network and customer command (octet 2, bit 2&amp;3)</p> <ul style="list-style-type: none"> <li>• Verify error free payload data looped back towards both network and customer</li> <li>• Verify maintenance status message from remote to CO in response to status request message (msg id 11) indicates both network and customer loopbacks are active at remote (octet 2, bit 3&amp;4)</li> <li>• If the remote cannot support multiple loopbacks requests, it shall respond with a maintenance status message that indicates its current active loopback.</li> </ul> |
|--|-----------------------------------------------------------------------------------------------------------------------------------------------------------------------------------------------------------------------------------------------------------------------------------------------------------------------------------------------------------------------------------------------------------------------------------------------------------------------------------------------------------------------------------------------------------------------------------------------------------------------------------------------------------------------------------------------------------------------------------------------------------------------------------------------------------------------------------------|

**B) Deactivate Bi-directional Loopback at Remote**

|                      |                                                                                                                                                                                                                                                                                                                                                                                                                                                                                                                                                                                                                                                       |
|----------------------|-------------------------------------------------------------------------------------------------------------------------------------------------------------------------------------------------------------------------------------------------------------------------------------------------------------------------------------------------------------------------------------------------------------------------------------------------------------------------------------------------------------------------------------------------------------------------------------------------------------------------------------------------------|
| Test Case Identifier | SH-5121-61                                                                                                                                                                                                                                                                                                                                                                                                                                                                                                                                                                                                                                            |
| Test Case Name       | Deactivate Bi-directional Loopback at Remote                                                                                                                                                                                                                                                                                                                                                                                                                                                                                                                                                                                                          |
| Test Purpose         | Test for correct operation                                                                                                                                                                                                                                                                                                                                                                                                                                                                                                                                                                                                                            |
| Standard Requirement |                                                                                                                                                                                                                                                                                                                                                                                                                                                                                                                                                                                                                                                       |
| Procedure            | Deactivate bi-directional loopback at CO from remote unit user interface.                                                                                                                                                                                                                                                                                                                                                                                                                                                                                                                                                                             |
| Expected Results     | <ul style="list-style-type: none"> <li>• Verify remote sends terminate loopback command set in command for STU-R set in system loopback command sent to CO. Either of the following. <ul style="list-style-type: none"> <li>A. Control for only terminate loopback toward the network and customer in command for STU-R (octet 3, bits 0&amp;1) set in system loopback message.</li> <li>OR</li> <li>B. Control for only clear all maintenance states in command for STU-R (octet 3 bit 6) set in system loopback message.</li> </ul> </li> <li>• Verify System Loopback command destination address to only STU-C (Destination Address=1)</li> </ul> |

|  |                                                                                                                                                                                                                                                                                                                                                                                                                                                                                                                                                                                                                                                                                                                                                                                                                                                                                                                                                                                                                                                                                                                                                                                                                                         |
|--|-----------------------------------------------------------------------------------------------------------------------------------------------------------------------------------------------------------------------------------------------------------------------------------------------------------------------------------------------------------------------------------------------------------------------------------------------------------------------------------------------------------------------------------------------------------------------------------------------------------------------------------------------------------------------------------------------------------------------------------------------------------------------------------------------------------------------------------------------------------------------------------------------------------------------------------------------------------------------------------------------------------------------------------------------------------------------------------------------------------------------------------------------------------------------------------------------------------------------------------------|
|  | <ul style="list-style-type: none"> <li>• Verify CO sends loopback control to (HLXR) by any of the following methods (all methods should work equivalently):             <ul style="list-style-type: none"> <li>A. Sending a system Maintenance broadcast message indicating only terminate loopback toward the customer in command for STU-R (octet 3 bit 0) set in system loopback message.</li> <li>OR</li> <li>B. Sending a system Maintenance broadcast message indicating only control for clear all maintenance states in command for STU-R (octet3 bit6) set in system loopback message.</li> <li>OR</li> <li>C. Sending an element loopback message to STU-R with the terminate loopback toward the network command (octet 2 bits 0&amp;1)</li> <li>OR</li> <li>D. Sending an element loopback message to STU-R with only control for clear all maintenance states in command (octet 2 bit 6)</li> </ul> </li> <li>• Verify loopbacks dropped and data path restored.</li> <li>• Verify maintenance status message from remote to CO in response to status request message (msg id 11) immediately after looping down indicates network and customer loopbacks are no longer active at remote (octet 2 bits 3&amp;4)</li> </ul> |
|--|-----------------------------------------------------------------------------------------------------------------------------------------------------------------------------------------------------------------------------------------------------------------------------------------------------------------------------------------------------------------------------------------------------------------------------------------------------------------------------------------------------------------------------------------------------------------------------------------------------------------------------------------------------------------------------------------------------------------------------------------------------------------------------------------------------------------------------------------------------------------------------------------------------------------------------------------------------------------------------------------------------------------------------------------------------------------------------------------------------------------------------------------------------------------------------------------------------------------------------------------|

#### **5.1.2.2 Remote Control Mode: Element Loop back Message (Msg id 10)**

This set of tests is applicable with any STU-C when the STU-R unit implements an Element Loop back Message control to activate loop backs at other units in the system.

**5.1.2.2.1 Network Loop back at CO****A) Activate Network Loop back at CO**

|                      |                                                                                                                                                                                                                                                                                                                                                                                                                                                                                                                                                  |
|----------------------|--------------------------------------------------------------------------------------------------------------------------------------------------------------------------------------------------------------------------------------------------------------------------------------------------------------------------------------------------------------------------------------------------------------------------------------------------------------------------------------------------------------------------------------------------|
| Test Case Identifier | SH-5122-10                                                                                                                                                                                                                                                                                                                                                                                                                                                                                                                                       |
| Test Case Name       | Activate Network Loop back at CO                                                                                                                                                                                                                                                                                                                                                                                                                                                                                                                 |
| Test Purpose         | Test correct operation                                                                                                                                                                                                                                                                                                                                                                                                                                                                                                                           |
| Standard Requirement |                                                                                                                                                                                                                                                                                                                                                                                                                                                                                                                                                  |
| Procedure            | Activate network loop back at CO from Remote Unit user interface                                                                                                                                                                                                                                                                                                                                                                                                                                                                                 |
| Expected Results     | <ul style="list-style-type: none"> <li>• Verify control for initiate loop back toward the network in command for STU-C (octet 2 bit 3) set in element loopback message</li> <li>• Verify error free payload data looped back towards network</li> <li>• Verify Element Loopback command destination address to only STU-C (Destination Address =1)</li> <li>• Verify maintenance status message from CO to Remote in response to status request message (msg id 11) indicates a network loopback is active at remote (octet 2 bit 3).</li> </ul> |

**B) Deactivate Network Loopback at CO**

Test both methods of deactivation

|                      |                                                                                                                                                                                                                                                                                                                                                                                                                                                                                                                                                                                 |
|----------------------|---------------------------------------------------------------------------------------------------------------------------------------------------------------------------------------------------------------------------------------------------------------------------------------------------------------------------------------------------------------------------------------------------------------------------------------------------------------------------------------------------------------------------------------------------------------------------------|
| Test Case Identifier | SH-5122-11                                                                                                                                                                                                                                                                                                                                                                                                                                                                                                                                                                      |
| Test Case Name       | Deactivate Network Loopback at CO                                                                                                                                                                                                                                                                                                                                                                                                                                                                                                                                               |
| Test Purpose         | Verify correct operation                                                                                                                                                                                                                                                                                                                                                                                                                                                                                                                                                        |
| Standard Requirement |                                                                                                                                                                                                                                                                                                                                                                                                                                                                                                                                                                                 |
| Procedure            | Deactivate network loopback at CO from remote unit user interface using terminate loopback toward network in element loopback message.                                                                                                                                                                                                                                                                                                                                                                                                                                          |
| Expected Results     | <ul style="list-style-type: none"> <li>• Verify only control for terminate loopback toward the network in command for STU-C (octet 2 bit 1) set in element loopback message.</li> <li>• Verify Element Loopback command destination address to only STU-C (Destination Address=1)</li> <li>• Verify Loopback dropped and data path restored.</li> <li>• Verify maintenance status message from CO to remote in response to status request message (Msg id 11) immediately after looping down indicates a network loopback is no longer active at CO (octet 2, bit3).</li> </ul> |

|                      |                                                                                                                                                                                                                                                                                                                                                                                                                                                                                                                                                                        |
|----------------------|------------------------------------------------------------------------------------------------------------------------------------------------------------------------------------------------------------------------------------------------------------------------------------------------------------------------------------------------------------------------------------------------------------------------------------------------------------------------------------------------------------------------------------------------------------------------|
| Test Case Identifier | SH-5122-12                                                                                                                                                                                                                                                                                                                                                                                                                                                                                                                                                             |
| Test Case Name       | Deactivate Network Loopback at CO                                                                                                                                                                                                                                                                                                                                                                                                                                                                                                                                      |
| Test Purpose         | Verify correct operation                                                                                                                                                                                                                                                                                                                                                                                                                                                                                                                                               |
| Standard Requirement |                                                                                                                                                                                                                                                                                                                                                                                                                                                                                                                                                                        |
| Procedure            | Deactivate network loopback at CO from remote unit user interface using clear all maintenance states in element loop back message.                                                                                                                                                                                                                                                                                                                                                                                                                                     |
| Expected Results     | <ul style="list-style-type: none"> <li>• Verify only control for clear all maintenance states in command for STU-C (octet 2, bit 6) set in system loopback message</li> <li>• Verify Element Loopback command destination address to only STU-C (Destination Address=1)</li> <li>• Verify Loopback dropped and data path restored.</li> <li>• Verify maintenance status message from CO to remote in response to status request message (Msg id 11) immediately after looping down indicates a network loopback is no longer active at CO (octet 2, bit 3).</li> </ul> |

#### 5.1.2.2.2 Customer Loopback at CO

##### A) **Activate Customer Loopback at CO**

|                      |                                                                                                                                                                                                                                                                                                                                                                                                                                                                                                                                                   |
|----------------------|---------------------------------------------------------------------------------------------------------------------------------------------------------------------------------------------------------------------------------------------------------------------------------------------------------------------------------------------------------------------------------------------------------------------------------------------------------------------------------------------------------------------------------------------------|
| Test Case Identifier | SH-5122-20                                                                                                                                                                                                                                                                                                                                                                                                                                                                                                                                        |
| Test Case Name       | Activate Customer Loopback at CO                                                                                                                                                                                                                                                                                                                                                                                                                                                                                                                  |
| Test Purpose         | Test correct operation                                                                                                                                                                                                                                                                                                                                                                                                                                                                                                                            |
| Standard Requirement |                                                                                                                                                                                                                                                                                                                                                                                                                                                                                                                                                   |
| Procedure            | Activate customer loopback at CO from remote unit user interface                                                                                                                                                                                                                                                                                                                                                                                                                                                                                  |
| Expected Results     | <ul style="list-style-type: none"> <li>• Verify only control for initiate loopback toward the customer in command for STU-C (octet 2 bit 2) set in element loopback message</li> <li>• Verify error free payload data looped back towards customer</li> <li>• Verify Element Loopback command destination address to only STU-C (Destination Address=1)</li> <li>• Verify maintenance status message from CO to remote in response to status request message (msg id 11) indicates a customer loopback is active at CO (octet 2 bit 4)</li> </ul> |

**B) Deactivate Customer Loopback at Remote**

Test both methods of deactivation

|                      |                                                                                                                                                                                                                                                                                                                                                                                                                                                                                                                                                                                |
|----------------------|--------------------------------------------------------------------------------------------------------------------------------------------------------------------------------------------------------------------------------------------------------------------------------------------------------------------------------------------------------------------------------------------------------------------------------------------------------------------------------------------------------------------------------------------------------------------------------|
| Test Case Identifier | SH-5122-21                                                                                                                                                                                                                                                                                                                                                                                                                                                                                                                                                                     |
| Test Case Name       | Deactivate Customer Loopback at Remote                                                                                                                                                                                                                                                                                                                                                                                                                                                                                                                                         |
| Test Purpose         | Verify correct operation                                                                                                                                                                                                                                                                                                                                                                                                                                                                                                                                                       |
| Standard Requirement |                                                                                                                                                                                                                                                                                                                                                                                                                                                                                                                                                                                |
| Procedure            | Deactivate customer loopback at CO from remote unit user interface using terminate loopback toward customer in element loopback message.                                                                                                                                                                                                                                                                                                                                                                                                                                       |
| Expected Results     | <ul style="list-style-type: none"> <li>• Verify control for terminate loopback toward the customer in command for STU-C (octet 2 bit 0) set in element loopback message.</li> <li>• Verify loopback dropped and data path restores.</li> <li>• Verify System Loopback command destination address to only STU-C (Destination Address=1)</li> <li>• Verify maintenance status message from CO to remote in response to status request message (Msg id 11) immediately after looping down indicates the customer loopback is no longer active at CO (octet 2, bit 3).</li> </ul> |

|                      |                                                                                                                                                                                                                                                                                                                                                                                                                                                                                                                                                                    |
|----------------------|--------------------------------------------------------------------------------------------------------------------------------------------------------------------------------------------------------------------------------------------------------------------------------------------------------------------------------------------------------------------------------------------------------------------------------------------------------------------------------------------------------------------------------------------------------------------|
| Test Case Identifier | SH-5122-22                                                                                                                                                                                                                                                                                                                                                                                                                                                                                                                                                         |
| Test Case Name       | Deactivate Customer Loopback at Remote                                                                                                                                                                                                                                                                                                                                                                                                                                                                                                                             |
| Test Purpose         | Verify correct operation                                                                                                                                                                                                                                                                                                                                                                                                                                                                                                                                           |
| Standard Requirement |                                                                                                                                                                                                                                                                                                                                                                                                                                                                                                                                                                    |
| Procedure            | Deactivate customer loopback at CO from remote unit user interface using clear all maintenance states in element loop back message.                                                                                                                                                                                                                                                                                                                                                                                                                                |
| Expected Results     | <ul style="list-style-type: none"> <li>• Verify control for clear all maintenance states in command for STU-C(octet 2, bit 6) set in element loopback message</li> <li>• Verify loopback dropped and data path restores.</li> <li>• Verify System Loopback command destination address to only STU-C (Destination Address=1)</li> <li>• Verify maintenance status message from CO to remote in response to status request message (Msg id 11) immediately after looping down indicates the customer loopback is no longer active at CO (octet 2, bit3).</li> </ul> |

**5.1.2.2.3 Bi-directional Loopback at CO (if supported by both ends)****A) Activate Bi-directional Loopback at CO**

|                      |                                                                                                                                                                                                                                                                                                                                                                                                                                                                                                                                                                                                                                                                                                                                                                |
|----------------------|----------------------------------------------------------------------------------------------------------------------------------------------------------------------------------------------------------------------------------------------------------------------------------------------------------------------------------------------------------------------------------------------------------------------------------------------------------------------------------------------------------------------------------------------------------------------------------------------------------------------------------------------------------------------------------------------------------------------------------------------------------------|
| Test Case Identifier | SH-5122-30                                                                                                                                                                                                                                                                                                                                                                                                                                                                                                                                                                                                                                                                                                                                                     |
| Test Case Name       | Activate Bi-directional Loopback at CO                                                                                                                                                                                                                                                                                                                                                                                                                                                                                                                                                                                                                                                                                                                         |
| Test Purpose         | Test correct operation if supported                                                                                                                                                                                                                                                                                                                                                                                                                                                                                                                                                                                                                                                                                                                            |
| Standard Requirement |                                                                                                                                                                                                                                                                                                                                                                                                                                                                                                                                                                                                                                                                                                                                                                |
| Procedure            | Activate bi-directional loopback at CO from remote unit user interface.                                                                                                                                                                                                                                                                                                                                                                                                                                                                                                                                                                                                                                                                                        |
| Expected Results     | <ul style="list-style-type: none"> <li>• Verify control for initiate loopback towards the network and customer in command for STU-C (octet 2 bits 2&amp;3) set in element loopback message</li> <li>• Verify Element Loopback command destination address to only STU-C (Destination Address=1)</li> <li>• Verify error free payload data looped back towards customer</li> <li>• Verify maintenance status message from CO to remote in response to status request message (msg id 11) indicates both the network and customer loopback are active at CO (octet 2 bits 3&amp;4)</li> <li>• If the remote cannot support multiple loopback requests, it shall respond with a maintenance status message that indicates its current active loopback.</li> </ul> |

**B) Deactivate Bi-directional Loopback at CO**

Test both methods of deactivation

|                      |                                                                                                                                                                                                                                                                                                                                                                      |
|----------------------|----------------------------------------------------------------------------------------------------------------------------------------------------------------------------------------------------------------------------------------------------------------------------------------------------------------------------------------------------------------------|
| Test Case Identifier | SH-5122-31                                                                                                                                                                                                                                                                                                                                                           |
| Test Case Name       | Deactivate Bi-directional Loopback at CO                                                                                                                                                                                                                                                                                                                             |
| Test Purpose         | Verify correct operation                                                                                                                                                                                                                                                                                                                                             |
| Standard Requirement |                                                                                                                                                                                                                                                                                                                                                                      |
| Procedure            | Deactivate bi-directional loopback at CO from remote unit user interface using terminate loopback toward network and customer in element loopback message.                                                                                                                                                                                                           |
| Expected Results     | <ul style="list-style-type: none"> <li>• Verify control for terminate loopback toward the network and customer in command for STU-C (octet 2 bit 0&amp;1) set in element loopback message</li> <li>• Verify loopback dropped and data path restores.</li> <li>• Verify Element Loopback command destination address to only STU-C (Destination Address=1)</li> </ul> |

|  |                                                                                                                                                                                                                                                                                              |
|--|----------------------------------------------------------------------------------------------------------------------------------------------------------------------------------------------------------------------------------------------------------------------------------------------|
|  | <ul style="list-style-type: none"> <li>Verify maintenance status message from CO to remote in response to status request message (Msg id 11) immediately after looping down indicates both the network and customer loopbacks are no longer active at CO (octet 2, bits 3&amp;4).</li> </ul> |
|--|----------------------------------------------------------------------------------------------------------------------------------------------------------------------------------------------------------------------------------------------------------------------------------------------|

|                      |                                                                                                                                                                                                                                                                                                                                                                                                                                                                                                                                                                                             |
|----------------------|---------------------------------------------------------------------------------------------------------------------------------------------------------------------------------------------------------------------------------------------------------------------------------------------------------------------------------------------------------------------------------------------------------------------------------------------------------------------------------------------------------------------------------------------------------------------------------------------|
| Test Case Identifier | SH-5122-32                                                                                                                                                                                                                                                                                                                                                                                                                                                                                                                                                                                  |
| Test Case Name       | Deactivate Bi-directional Loopback at CO                                                                                                                                                                                                                                                                                                                                                                                                                                                                                                                                                    |
| Test Purpose         | Verify correct operation                                                                                                                                                                                                                                                                                                                                                                                                                                                                                                                                                                    |
| Standard Requirement |                                                                                                                                                                                                                                                                                                                                                                                                                                                                                                                                                                                             |
| Procedure            | Deactivate customer loopback at CO from remote unit user interface using clear all maintenance states in element loop back message.                                                                                                                                                                                                                                                                                                                                                                                                                                                         |
| Expected Results     | <ul style="list-style-type: none"> <li>Verify only control for clear all maintenance states in command for STU-C(octet 2, bit 6) set in element loopback message</li> <li>Verify loopback dropped and data path restores.</li> <li>Verify Element Loopback command destination address to only STU-C (Destination Address=1)</li> <li>Verify maintenance status message from CO to remote in response to status request message (Msg id 11) immediately after looping down indicates both the network and customer loopbacks are no longer active at CO (octet 2, bits 3&amp;4).</li> </ul> |

### 5.1.2.3 Remote Control Mode: Remote Loopback: CO Display

This test is for remote units that process remote loopbacks issued at the remote unit user interface locally with no CO unit involvement

#### 5.1.2.3.1 Network Loop back at Remote

##### A) Activate Network Loop back at Remote

|                      |                                                                                                              |
|----------------------|--------------------------------------------------------------------------------------------------------------|
| Test Case Identifier | SH-5123-10                                                                                                   |
| Test Case Name       | Activate Network Loop back at Remote                                                                         |
| Test Purpose         | Test correct operation                                                                                       |
| Standard Requirement |                                                                                                              |
| Procedure            | Activate network loop back at Remote from Remote Unit user interface                                         |
| Expected Results     | <ul style="list-style-type: none"> <li>Verify error free payload data looped back towards network</li> </ul> |



|  |                                                                                                                                                                                                                          |
|--|--------------------------------------------------------------------------------------------------------------------------------------------------------------------------------------------------------------------------|
|  | <ul style="list-style-type: none"> <li>Verify maintenance status message from Remote to CO in response to status request message (msg id 11) indicates a network loopback is active at remote (octet 2 bit 3)</li> </ul> |
|--|--------------------------------------------------------------------------------------------------------------------------------------------------------------------------------------------------------------------------|

### B) Deactivate Network Loopback at Remote

|                      |                                                                                                                                                                                                                                                                                                                             |
|----------------------|-----------------------------------------------------------------------------------------------------------------------------------------------------------------------------------------------------------------------------------------------------------------------------------------------------------------------------|
| Test Case Identifier | SH-5123-11                                                                                                                                                                                                                                                                                                                  |
| Test Case Name       | Deactivate Network Loopback at Remote                                                                                                                                                                                                                                                                                       |
| Test Purpose         | Verify correct operation                                                                                                                                                                                                                                                                                                    |
| Standard Requirement |                                                                                                                                                                                                                                                                                                                             |
| Procedure            | Deactivate network loopback at remote from remote unit user interface                                                                                                                                                                                                                                                       |
| Expected Results     | <ul style="list-style-type: none"> <li>Verify loopback dropped and data path restored.</li> <li>Verify maintenance status message from Remote to CO in response to status request message (msg id11) immediately after looping down indicates the network loopback is no longer active at remote (Octet 2 bit 3)</li> </ul> |

#### 5.1.2.3.2 Customer Loop back at Remote

### A) Activate Customer Loop back at Remote

|                      |                                                                                                                                                                                                                                                                                               |
|----------------------|-----------------------------------------------------------------------------------------------------------------------------------------------------------------------------------------------------------------------------------------------------------------------------------------------|
| Test Case Identifier | SH-5123-20                                                                                                                                                                                                                                                                                    |
| Test Case Name       | Activate Customer Loop back at Remote                                                                                                                                                                                                                                                         |
| Test Purpose         | Test correct operation                                                                                                                                                                                                                                                                        |
| Standard Requirement |                                                                                                                                                                                                                                                                                               |
| Procedure            | Activate customer loop back at Remote from Remote Unit user interface                                                                                                                                                                                                                         |
| Expected Results     | <ul style="list-style-type: none"> <li>Verify error free payload data looped back towards network</li> <li>Verify maintenance status message from Remote to CO in response to status request message (msg id 11) indicates a customer loopback is active at remote (octet 2 bit 4)</li> </ul> |

### B) Deactivate Network Loopback at Remote

|                      |                                       |
|----------------------|---------------------------------------|
| Test Case Identifier | SH-5123-21                            |
| Test Case Name       | Deactivate Network Loopback at Remote |
| Test Purpose         | Verify correct operation              |

|                      |                                                                                                                                                                                                                                                                                                                                   |
|----------------------|-----------------------------------------------------------------------------------------------------------------------------------------------------------------------------------------------------------------------------------------------------------------------------------------------------------------------------------|
| Standard Requirement |                                                                                                                                                                                                                                                                                                                                   |
| Procedure            | Deactivate network loopback at remote from remote unit user interface                                                                                                                                                                                                                                                             |
| Expected Results     | <ul style="list-style-type: none"> <li>• Verify loopback dropped and data path restored.</li> <li>• Verify maintenance status message from Remote to CO in response to status request message (msg id11) immediately after looping down indicates the customer loopback is no longer active at remote (Octet 2 bit 4).</li> </ul> |

#### 5.1.2.3.3 Bi-directional Loop back at Remote (if supported by Remote)

##### A) **Activate Bi-directional Loop back at Remote**

|                      |                                                                                                                                                                                                                                                                                                                                              |
|----------------------|----------------------------------------------------------------------------------------------------------------------------------------------------------------------------------------------------------------------------------------------------------------------------------------------------------------------------------------------|
| Test Case Identifier | SH-5123-30                                                                                                                                                                                                                                                                                                                                   |
| Test Case Name       | Activate Bi-directional Loop back at Remote                                                                                                                                                                                                                                                                                                  |
| Test Purpose         | Test correct operation                                                                                                                                                                                                                                                                                                                       |
| Standard Requirement |                                                                                                                                                                                                                                                                                                                                              |
| Procedure            | Activate bi-directional loop back at Remote from Remote Unit user interface                                                                                                                                                                                                                                                                  |
| Expected Results     | <ul style="list-style-type: none"> <li>• Verify error free payload data looped back towards both network and customer.</li> <li>• Verify maintenance status message from Remote to CO in response to status request message (msg id 11) indicates that network and customer loopbacks are active at remote (octet 2 bits 3&amp;4)</li> </ul> |

##### B) **Deactivate Bi-directional Loopback at Remote**

|                      |                                                                                                                                                                                                                                                                                                                                          |
|----------------------|------------------------------------------------------------------------------------------------------------------------------------------------------------------------------------------------------------------------------------------------------------------------------------------------------------------------------------------|
| Test Case Identifier | SH-5123-31                                                                                                                                                                                                                                                                                                                               |
| Test Case Name       | Deactivate Bi-directional Loopback at Remote                                                                                                                                                                                                                                                                                             |
| Test Purpose         | Verify correct operation                                                                                                                                                                                                                                                                                                                 |
| Standard Requirement |                                                                                                                                                                                                                                                                                                                                          |
| Procedure            | Deactivate bi-directional loopback at remote from remote unit user interface                                                                                                                                                                                                                                                             |
| Expected Results     | <ul style="list-style-type: none"> <li>• Verify loopbacks dropped and data path restored.</li> <li>• Verify maintenance status message from Remote to CO in response to status request message (msg id11) immediately after looping down indicates that both loopbacks are no longer active at remote (Octet 2 bits 3&amp;4).</li> </ul> |

## 5.2 EOC Messaging Tests

The scope of the EOC Messaging tests will apply to STU-x devices involved in testing EOC interoperability and functionality. Testing includes verification of SHDSL synchronization and EOC compatibility, both of which are inherent to SHDSL interoperability. When 4-wire is supported, the same EOC message is required to be passed by both loops. To verify, apply the following test cases either using one in Data mode and the other disconnected or both in the data mode. Table 9.6 of G.991.2 identifies “optional initiating units”. An acceptable response to all messages initiated by the optional initiating unit is “UTC”.

### 5.2.1 EOC compatibility

Message ID and paragraph References are from ITU-T G.991.2.

EOC Messages 1 and 129 as defined in Section 9.5.5.7.1 and 9.5.5.7.2. This includes verification of:

- Discovery Probe Message
- Discovery Response Message

|                      |                                                                                                                                                                                                          |
|----------------------|----------------------------------------------------------------------------------------------------------------------------------------------------------------------------------------------------------|
| Test Case Identifier | SH-5210-10                                                                                                                                                                                               |
| Test Case Name       | EOC Discovery Messages                                                                                                                                                                                   |
| Test Purpose         | Test the EOC Discovery Probe and Response messages                                                                                                                                                       |
| Standard Requirement | EOC Messages 1 and 129 as defined in Section 9.5.5.7.1 and 9.5.5.7.2                                                                                                                                     |
| Procedure            | Send probe message and check response                                                                                                                                                                    |
| Expected Results     | <ul style="list-style-type: none"> <li>• Discovery Probe Message 1 sent and Discovery Response Message 129 should be received.</li> <li>• Message ID &amp; hopcount = number of span elements</li> </ul> |

EOC Messages 2 and 130 as defined in Section 9.5.5.7.3 and 9.5.5.7.4. This includes verification of :

- Inventory Request Message
- Inventory Response Message

|                      |                                                                                                   |
|----------------------|---------------------------------------------------------------------------------------------------|
| Test Case Identifier | SH-5210-20                                                                                        |
| Test Case Name       | EOC Inventory Messages                                                                            |
| Test Purpose         | Test the EOC Inventory Request and Response messages                                              |
| Standard Requirement | EOC Messages 2 and 130 as defined in Section 9.5.5.7.3 and 9.5.5.7.4                              |
| Procedure            | Send request message and check response                                                           |
| Expected Results     | <ul style="list-style-type: none"> <li>• Verify Message ID and Inventory data received</li> </ul> |

EOC Messages 3 and 131 as defined in Section 9.5.5.7.5 and 9.5.5.7.7. This includes verification of:

- SHDSL Configuration Request Message
- SHDSL Configuration Response Message

|                      |                                                                                                                                                                                                                                                                                                                                                                                |
|----------------------|--------------------------------------------------------------------------------------------------------------------------------------------------------------------------------------------------------------------------------------------------------------------------------------------------------------------------------------------------------------------------------|
| Test Case Identifier | SH-5210-30                                                                                                                                                                                                                                                                                                                                                                     |
| Test Case Name       | EOC Configuration                                                                                                                                                                                                                                                                                                                                                              |
| Test Purpose         | Test the EOC Configuration Request and Response messages                                                                                                                                                                                                                                                                                                                       |
| Standard Requirement | EOC Messages 3 and 131 as defined in Section 9.5.5.7.5 and 9.5.5.7.7                                                                                                                                                                                                                                                                                                           |
| Procedure            | Send request and check response                                                                                                                                                                                                                                                                                                                                                |
| Expected Results     | <ul style="list-style-type: none"> <li>• Verify Message ID; Change SNR Margin Threshold; Change Loop Attenuation Threshold and verify the values of the response are set to the new values, after they have been applied. If a transceiver unit is unable to comply with the request, the bit in the Compliance Octet is set and the current settings are reported.</li> </ul> |

EOC Messages 4 and 132 as defined in Section 9.5.5.6. This includes verification of:

- TBD (Application Interface Configuration)
- Response Message ID 132 not defined

|                      |                                      |
|----------------------|--------------------------------------|
| Test Case Identifier | SH-5210-40                           |
| Test Case Name       | TBD                                  |
| Test Purpose         | Reserved probe and Response messages |
| Standard Requirement | EOC Messages 4 and 132               |
| Procedure            | TBD                                  |
| Expected Results     | TBD                                  |

EOC Messages 5 and 133 as defined in Section 9.5.5.7.6 and 9.5.5.7.8. This includes verification of:

- Loopback Timeout Configuration Request Message
- Loopback Timeout Configuration Response Message

|                      |                                                                                                            |
|----------------------|------------------------------------------------------------------------------------------------------------|
| Test Case Identifier | SH-5210-50                                                                                                 |
| Test Case Name       | EOC Loopback Timeout Configuration messages                                                                |
| Test Purpose         | Verify Probe and Response messages                                                                         |
| Standard Requirement | EOC Messages 5 and 133 as defined in Section 9.5.5.7.6 and 9.5.5.7.8                                       |
| Procedure            | Send probe messages and check responses                                                                    |
| Expected Results     | Verify response sent after the applicable configuration changes have been made. The values of the response |

|  |                                                                                                                                                                                                                                                                                                                                                                                                                                                             |
|--|-------------------------------------------------------------------------------------------------------------------------------------------------------------------------------------------------------------------------------------------------------------------------------------------------------------------------------------------------------------------------------------------------------------------------------------------------------------|
|  | <p>shall be set to the new values, after they have been applied. If a transceiver unit is unable to comply with the request, the bit in the Compliance Octet is set and the current settings are reported. If the Config Request message was received with a Config Type of "Read-Only," then no changes are made to the current configuration and the current values are reported.</p> <p>Verify that the timer functions properly in the remote unit.</p> |
|--|-------------------------------------------------------------------------------------------------------------------------------------------------------------------------------------------------------------------------------------------------------------------------------------------------------------------------------------------------------------------------------------------------------------------------------------------------------------|

EOC Messages 6,7, and 134, 8 and 136 as defined in Section 9.5.5.7.16 and 9.5.5.7.17. This includes verification of:

- Virtual Terminal Connect Request Message
- Virtual Terminal Disconnect Request Message
- Keyboard Data Message Request
- Virtual Terminal Connect Response Message
- Screen Data Message Response

|                      |                                                                                                                                                                                                                                                                                                                                                                                                                                                                                                                                                                                                                                                                                                                                                                                                                                                                                                                     |
|----------------------|---------------------------------------------------------------------------------------------------------------------------------------------------------------------------------------------------------------------------------------------------------------------------------------------------------------------------------------------------------------------------------------------------------------------------------------------------------------------------------------------------------------------------------------------------------------------------------------------------------------------------------------------------------------------------------------------------------------------------------------------------------------------------------------------------------------------------------------------------------------------------------------------------------------------|
| Test Case Identifier | SH-5210-60                                                                                                                                                                                                                                                                                                                                                                                                                                                                                                                                                                                                                                                                                                                                                                                                                                                                                                          |
| Test Case Name       | Virtual Terminal Connect/Disconnect                                                                                                                                                                                                                                                                                                                                                                                                                                                                                                                                                                                                                                                                                                                                                                                                                                                                                 |
| Test Purpose         | Verify virtual terminal connections can be established and disconnected                                                                                                                                                                                                                                                                                                                                                                                                                                                                                                                                                                                                                                                                                                                                                                                                                                             |
| Standard Requirement | EOC Messages 6, 7, 134, 136 as defined in Section 9.5.5.7.16 and 9.5.5.7.17                                                                                                                                                                                                                                                                                                                                                                                                                                                                                                                                                                                                                                                                                                                                                                                                                                         |
| Procedure            | Send messages to establish a virtual connection, exchange keyboard messages/response, and disconnect.                                                                                                                                                                                                                                                                                                                                                                                                                                                                                                                                                                                                                                                                                                                                                                                                               |
| Expected Results     | <ul style="list-style-type: none"> <li>• Request a connection, wait for "connect" status response before using the connection.</li> <li>• The connection remains until a disconnect request is processed or, if implemented, a timeout occurs. At least one session shall be supported by the STU-C. STU-R and SRU may silently ignore the connect request or may respond with a "no connect" status if terminal screens are not supported.</li> <li>• The connect/disconnect process is necessary for handling the case where keyboard messages are received from more than one device. If a unit cannot accommodate another connect request it shall send the "no connect" response.</li> <li>• The connect request message can be sent to cause a refresh of the current screen. When a connect request is accepted the "connect" response shall be transmitted, followed by screen messages with the</li> </ul> |

|  |                                                                                                                                                                                                       |
|--|-------------------------------------------------------------------------------------------------------------------------------------------------------------------------------------------------------|
|  | <p>current screen. If this is a new connection then the first screen shall be sent.</p> <ul style="list-style-type: none"> <li>• Verify that Keyboard and Screen messages can be exchanged</li> </ul> |
|--|-------------------------------------------------------------------------------------------------------------------------------------------------------------------------------------------------------|

EOC Messages 9,10 and 137 as defined in Section 9.5.5.7.18, 9.5.5.7.19 and 9.5.5.7.20. This includes verification of:

- Maintenance Request – System Loopback Message
- Maintenance Request – Element Loopback Message
- Maintenance Status Response Message

These maintenance messages should be verified during the various loop back tests conducted by the test cases contained in Section 5.1 of this specification

EOC Messages 11,12, 137, 139, 140 and 141 as defined in Sections 9.5.5.7.11, 9.5.5.7.12, 9.5.5.7.13, 9.5.5.7.14 and 9.5.5.7.15. This includes verification of:

- Status Request
- Full Status Request
- Status Response/SNR Message
- SHDSL Network Side Performance Status Message
- SHDSL Customer Side Performance Status Message

|                      |                                                                                                                                                                                                                                                                                                                                                                                                |
|----------------------|------------------------------------------------------------------------------------------------------------------------------------------------------------------------------------------------------------------------------------------------------------------------------------------------------------------------------------------------------------------------------------------------|
| Test Case Identifier | SH-5210-70                                                                                                                                                                                                                                                                                                                                                                                     |
| Test Case Name       | EOC Status Messages                                                                                                                                                                                                                                                                                                                                                                            |
| Test Purpose         | Test the various EOC Status Probe and Response messages                                                                                                                                                                                                                                                                                                                                        |
| Standard Requirement | EOC Messages 11, 12, 137, 139, 140 and 141 as defined in Section 9.5.5.7.11, 9.5.5.7.12, 9.5.5.7.13, 9.5.5.7.14 and 9.5.5.7.15                                                                                                                                                                                                                                                                 |
| Procedure            | Send series of status probe messages and check responses                                                                                                                                                                                                                                                                                                                                       |
| Expected Results     | <ul style="list-style-type: none"> <li>• Verify correct operation and responses (mandatory and optional if supported) to the various status messages</li> <li>• Check the value of each status response field and verify with the remote value.</li> <li>• Change the conditions that can affect those statuses and verify that those changes are reported in the status responses.</li> </ul> |

EOC Message 15 as defined in Section 9.5.5.7.21. This includes verification of:

- Soft Restart/Power Backoff Control Message

|                      |                                                                                                                                                                                                                                                                              |
|----------------------|------------------------------------------------------------------------------------------------------------------------------------------------------------------------------------------------------------------------------------------------------------------------------|
| Test Case Identifier | SH-5210-80                                                                                                                                                                                                                                                                   |
| Test Case Name       | EOC Soft Restart and Power Backoff                                                                                                                                                                                                                                           |
| Test Purpose         | Verify ability to switch receiver between default and selected modes of power backoff                                                                                                                                                                                        |
| Standard Requirement | EOC Message 15 as defined in Section 9.5.5.7.21                                                                                                                                                                                                                              |
| Procedure            | Send probe message 15 and check response. If default mode is set, PBO shall be set to the default value. Otherwise, in selected mode, PBO may be negotiated through G.994.1 to another value.                                                                                |
| Expected Results     | <ul style="list-style-type: none"> <li>• Verify Network side Power Backoff Setting</li> <li>• Verify Network side Soft Restart after 5 seconds</li> <li>• Verify Customer side Power Backoff Setting</li> <li>• Verify Customer side Soft Restart after 5 seconds</li> </ul> |

EOC Message 17 and 145 as defined in Section E.9.4.7 and E.9.4.8 This includes verification of:

- ATM Cell Status Request
- ATM Cell Status Information

|                      |                                                                                                                                                                                                                                                                                                         |
|----------------------|---------------------------------------------------------------------------------------------------------------------------------------------------------------------------------------------------------------------------------------------------------------------------------------------------------|
| Test Case Identifier | SH-5210-90                                                                                                                                                                                                                                                                                              |
| Test Case Name       | ATM Cell Status                                                                                                                                                                                                                                                                                         |
| Test Purpose         | Test ability to get ATM OAM Cell Status information over the EOC                                                                                                                                                                                                                                        |
| Standard Requirement | EOC Message 17 and 145 as defined in Section E.9.4.7 and E.9.4.8                                                                                                                                                                                                                                        |
| Procedure            | Send ATM Cell Status Request probe message 17 and check ATM Cell Status Information response                                                                                                                                                                                                            |
| Expected Results     | <ul style="list-style-type: none"> <li>• Poll and verify all ATM Cell Status functions such as Header Error Check (HEC), Loss of Cell Delineation (LCD), etc. alarms</li> <li>• Poll message on clean circuit</li> <li>• An acceptable response for a unit which does not support ATM is UTC</li> </ul> |

EOC Messages 18 and 146 as defined in section 9.5.5.7.9 and 9.5.5.7.10. This includes verification of:

- STU-R Configuration Request – Management
- Configuration Response – Management

|                      |                                                          |
|----------------------|----------------------------------------------------------|
| Test Case Identifier | SH-5210-100                                              |
| Test Case Name       | STU-R Configuration Messages                             |
| Test Purpose         | Test Configuration Message ability to enable and disable |

|                      |                                                                                                                                                                                                                                                                                                                                 |
|----------------------|---------------------------------------------------------------------------------------------------------------------------------------------------------------------------------------------------------------------------------------------------------------------------------------------------------------------------------|
|                      | STU-R management and Response messages                                                                                                                                                                                                                                                                                          |
| Standard Requirement | EOC Messages 18 and 146 as defined in Section 9.5.5.7.9 and 9.5.5.7.10                                                                                                                                                                                                                                                          |
| Procedure            | Send probe message 18 and check responses                                                                                                                                                                                                                                                                                       |
| Expected Results     | <ul style="list-style-type: none"> <li>• Verify that STU-R management flow can be enabled and disabled.</li> <li>• Verify that Config Response – Management message is sent to acknowledge the Config Request – Management message. Check that messages 2-12 are not initiated by STU-R after this message exchange.</li> </ul> |

EOC Message 144 as defined in Section 9.5.5.7.26. This includes verification of:

- Generic Unable to Comply (UTC)

Response to a message that the unit is not able to process.

- Check that an indication is given of the Message ID of the request message.

|                      |                                                                                         |
|----------------------|-----------------------------------------------------------------------------------------|
| Test Case Identifier | SH-5210-110                                                                             |
| Test Case Name       | EOC Generic Unable to Comply (UTC) Message                                              |
| Test Purpose         | Test the EOC ability to send a message indicating it is unable to comply with a request |
| Standard Requirement | EOC Messages 144 as defined in Section 9.5.5.7.26                                       |
| Procedure            | Send a probe message that the far end can not comply with.                              |
| Expected Results     | Verify receipt of UTC message                                                           |

Reference table for the above messages are given below in Table 14. The full set of EOC Message IDs is contained in Table 9-6/G.991.2.

TABLE 14: EOC MESSAGES

| Probe Message         |    | Verify                                                                                                 | Response Message ID |
|-----------------------|----|--------------------------------------------------------------------------------------------------------|---------------------|
| Type                  | ID |                                                                                                        |                     |
| Discovery Probe       | 1  | Hopcount = the number of span elements                                                                 | 129                 |
| Inventory Request     | 2  | Inventory data received                                                                                | 130                 |
| Configuration Request | 3  | <ul style="list-style-type: none"> <li>• Change SNR Margin Threshold</li> <li>• Change Loop</li> </ul> | 131                 |



|                                          |    | Attenuation Threshold                                                                                                                                                                                                                                                                                                                                                                                                                                               |                 |
|------------------------------------------|----|---------------------------------------------------------------------------------------------------------------------------------------------------------------------------------------------------------------------------------------------------------------------------------------------------------------------------------------------------------------------------------------------------------------------------------------------------------------------|-----------------|
| Application Interface Configuration      | 4  | <ul style="list-style-type: none"> <li>• Future use TBD</li> </ul>                                                                                                                                                                                                                                                                                                                                                                                                  | 132             |
| Configuration Request – Loopback Timeout | 5  | Configure Time/Date/LBTO <ul style="list-style-type: none"> <li>• Set LBTO to 0 (no timeout)</li> <li>• Change LBTO to other settings</li> <li>• Set Date</li> <li>• Set Time</li> </ul>                                                                                                                                                                                                                                                                            | 133             |
| Virtual Terminal Connect Request         | 6  | Connect Virtual Terminal <ul style="list-style-type: none"> <li>• Connect VT from STU-C</li> <li>• Connect VT from STU-R</li> </ul>                                                                                                                                                                                                                                                                                                                                 | 134             |
| Virtual Terminal Disconnect Request      | 7  | Disconnect Virtual Terminal                                                                                                                                                                                                                                                                                                                                                                                                                                         |                 |
| Keyboard Data Message                    | 8  | Accept keyboard messages while in Virtual Terminal session                                                                                                                                                                                                                                                                                                                                                                                                          | 136             |
| Maintenance Request – System Loopback    | 9  | Initiate loopbacks; verify screen reflects properly on both units <ul style="list-style-type: none"> <li>• STU-C loopback to network</li> <li>• STU-C loopback to customer</li> <li>• STU-R loopback to network</li> <li>• STU-R loopback to customer</li> <li>• STU-R bilateral loopback</li> <li>• Loopdown all from STU-C</li> <li>• Loopdown all from STU-R</li> </ul>                                                                                          | 137             |
| Maintenance Request – Element Loopback   | 10 | Initiate loopbacks; verify screen reflects properly on both units <ul style="list-style-type: none"> <li>• STU-C loopback to network</li> <li>• STU-C loopback to customer</li> <li>• STU-R loopback to network</li> <li>• STU-R loopback to customer</li> <li>• STU-R bilateral loopback</li> <li>• Loopdown all from STU-C</li> <li>• Loopdown all from STU-R</li> </ul>                                                                                          | 137             |
| Status Request                           | 11 | Poll for alarms and performance status <ul style="list-style-type: none"> <li>• Poll message on clean circuit</li> <li>• Poll message with SHDSL faults               <ul style="list-style-type: none"> <li>❖ SNR Margin alarm</li> <li>❖ Loop Attenuation alarm</li> <li>❖ DC Continuity Fault</li> <li>❖ SHDSL LOSW defect</li> <li>❖ ES Count</li> <li>❖ SES Count</li> <li>❖ UAS Count</li> <li>❖ Device Fault</li> <li>❖ Power Backoff</li> </ul> </li> </ul> | 139<br>140, 141 |

|                                            |    |                                     |              |
|--------------------------------------------|----|-------------------------------------|--------------|
| Full Status Request                        | 12 | Poll full status with clean circuit | 137, 140-141 |
| Soft restart/Power backoff disable request | 15 | Verify restart after 5 seconds      |              |
| ATM Cell Status Request                    | 17 | ATM Cell Status Information         | 145          |
| STU-R Configuration Request – Management   | 18 | Configuration Response – Management | 146          |
|                                            |    | Unable to Comply (UTC)              | 144          |

### 5.3 Virtual Terminal Disconnect Tests

Interoperability issues on virtual terminal disconnection were identified due to different disconnect procedures under different applications. We may choose to use some of the tests that have been incorporated into HDSL2 Interoperability.

## 6 SHDSL CPE Application Level Testing

SHDSL CPE products for broadband access may include bridging, routing or other features like Circuit Emulation Service (CES), Frame Relay over ATM (FRF.5 and FRF.8) and VoDSL.

Interoperability requires these services to be interoperable as well. Additionally the performance of those additional features should cover operation at the highest possible line speeds. The following proposes some basic interoperability and performance tests for routing, bridging, and CES enabled SHDSL CPEs with DSLAMs. The tests might equally be used for other symmetric DSL solutions.

### 6.1 Required test equipment

The Table 15 summarizes the required test equipment for the interoperability and performance tests described in this document.

TABLE 15: REQUIRED TEST EQUIPMENT

| Test equipment          | Quantity | Icon  | Comments                                                                                                                                                              |
|-------------------------|----------|-------|-----------------------------------------------------------------------------------------------------------------------------------------------------------------------|
| Device under test       | 2        | DUT   |                                                                                                                                                                       |
| DSLAM                   | 1        | DSLAM | Includes a SHDSL card and an uplink card. The uplink matches the interface type on the BAS. If BAS functions are included in the DSLAM, a LAN interface is available. |
| Broadband Access Server | 1        | BAS   | The BAS has an interface matching the DSLAM uplink interface type. It has as well a LAN interface. It can terminate RFC2684, PPPoA and                                |

|                                  |   |                                                                                   |                                                                                                                                                                                                                                                                                                                                                                                                                                                                           |
|----------------------------------|---|-----------------------------------------------------------------------------------|---------------------------------------------------------------------------------------------------------------------------------------------------------------------------------------------------------------------------------------------------------------------------------------------------------------------------------------------------------------------------------------------------------------------------------------------------------------------------|
|                                  |   |                                                                                   | PPPoE.                                                                                                                                                                                                                                                                                                                                                                                                                                                                    |
| Traffic analyser                 | 2 |  | Broadband Access Server (BAS) or traffic Generator/Analyzer with BAS functionality generates traffic and analyses reception of traffic. This includes error measurement and throughput performance measurement. The traffic analyzer has the following interfaces: <ul style="list-style-type: none"> <li>• Ethernet interface matching Ethernet interface on DUT, BAS and DSLAM</li> <li>• G703 2Mbit/s or serial V10/V11 interface matching interface on DUT</li> </ul> |
| Jitter and wander test equipment | 2 | J&W                                                                               | The jitter and wander test equipment has a G703 2Mbit/s interface and measures whether the received signal is within ITU-T G.823 limits.                                                                                                                                                                                                                                                                                                                                  |

## **ATM Level test**

### **6.1.1 Test purpose**

The purpose of this test is to show that an ATM PVC can be set-up between the DUT and the DSLAM. Optionally auto-configuration is used for this purpose. The test is applicable for all ATM based DUT – DSLAM combinations.

The ATM TC layer of SHDSL is consistent with ITU-T I.432.1. It defines functions such as:

- Rate decoupling between ATM layer and the synchronous PMS-TC layer
- Insertion/Extraction of Idle cells (an idle cell inserted at the transmit side has to be extracted at the remote side)
- Insertion/Extraction of ATM Header Error Check (HEC) byte
- Cell payload scrambling/descrambling for SDH-based systems
- Cell delineation in the receive channel
- Bit timing and ordering (MSB sent first with bit timing synchronous to the STU-c downstream timing base)

### **6.1.2 Test set-up**

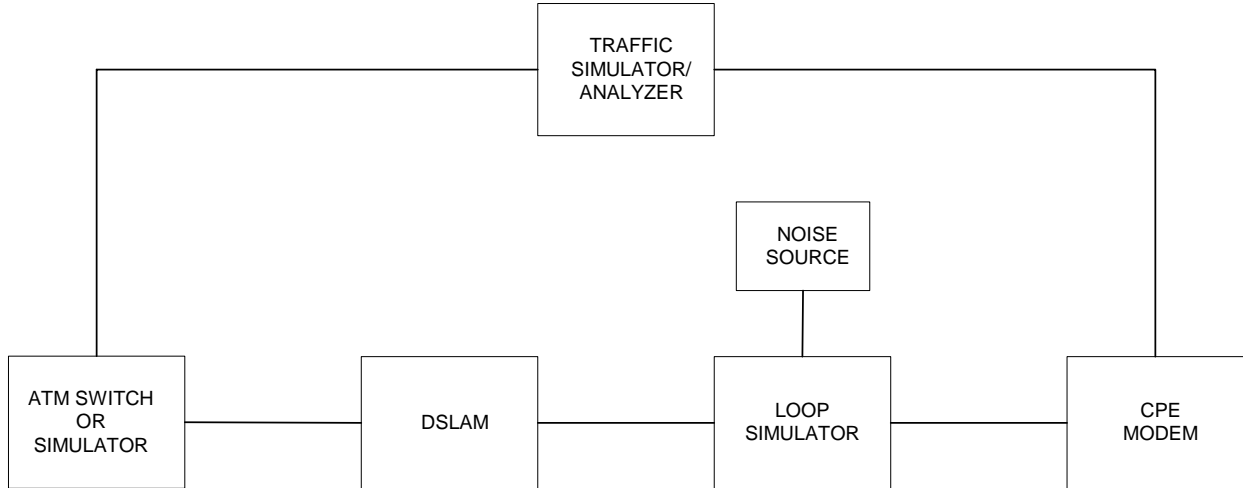

**Figure 15: Test setup for ATM layer tests for SHDSL modems with Ethernet Interface**

The SHDSL line interfaces are interconnected with a short twisted pair cable.

**6.1.3 ATM Connectivity Tests**

Test configuration can be conducted essentially by any suitable connection configuration for basic ATM level tests. Figure 15 illustrates the test set up for ATM layer test cases for SHDSL modems with Ethernet interfaces. Tests cases should be developed for the following:

- Maximum number of VCs
- Maximum VPI/VCI range
- Default VPI/VCI
- SVC support – if supported
- QoS support for CBR traffic
- QoS support for nrtVBR/UBR traffic
- QoS support for rtVBR traffic
- Loopback at ATU-R
- F5 OAM support

|                      |                                                                            |
|----------------------|----------------------------------------------------------------------------|
| Test Case Identifier | SH-6130-01                                                                 |
| Test Case Name       | <b>Maximum number of VC's</b>                                              |
| Test Purpose         | Verify device supports the number of VC's claimed in product documentation |
| Standard Requirement |                                                                            |
| Procedure            | Cross connect VC's between the ATU-R and the ATU-C                         |

|                        |                                                                                                                                                                                   |
|------------------------|-----------------------------------------------------------------------------------------------------------------------------------------------------------------------------------|
|                        | until 16 VC's are successfully configured or until the system will not accept any more, which ever is less.                                                                       |
| Additional Information | Test Configuration using Figure 15<br>The ATM switch or simulator may be removed if the traffic simulator/analyzer is capable of terminating ATM traffic directly from the DSLAM. |
| Expected Results       | Maximum number of VC's is the same as that published in the ATU-R or DSLAM documentation, whichever is less.                                                                      |

|                        |                                                                                                                                                                                   |
|------------------------|-----------------------------------------------------------------------------------------------------------------------------------------------------------------------------------|
| Test Case Identifier   | SH-6130-02                                                                                                                                                                        |
| Test Case Name         | <b>Maximum VPI/VCI Range</b>                                                                                                                                                      |
| Test Purpose           | Verify VPI/VCI support within published range                                                                                                                                     |
| Standard Requirement   |                                                                                                                                                                                   |
| Procedure              | Configure VPI/VCI just within the published range, and just outside the published range.                                                                                          |
| Additional Information | Test Configuration using Figure 15<br>The ATM switch or simulator may be removed if the traffic simulator/analyzer is capable of terminating ATM traffic directly from the DSLAM. |
| Expected Results       | Verify that capability to choose VPI/VCI falls within published range for the DSLAM or the ATU-R modem, whichever is more restrictive.                                            |

|                        |                                                                                                                                                                                   |
|------------------------|-----------------------------------------------------------------------------------------------------------------------------------------------------------------------------------|
| Test Case Identifier   | SH-6130-03                                                                                                                                                                        |
| Test Case Name         | <b>Default VCI/VPI</b>                                                                                                                                                            |
| Test Purpose           | Test for proper default value (default VP/VC is 0/35)                                                                                                                             |
| Standard Requirement   |                                                                                                                                                                                   |
| Procedure              | With the ATU-R/CPE in its default configuration, cross connect a circuit in this default VPI/VCI range and pass cells over the connection.                                        |
| Additional Information | Test Configuration using Figure 15<br>The ATM switch or simulator may be removed if the traffic simulator/analyzer is capable of terminating ATM traffic directly from the DSLAM. |
| Expected Results       | Cells must be passed across the connection using the default VPI/VCI value and those from the CPE General Information table.                                                      |

|                      |                                             |
|----------------------|---------------------------------------------|
| Test Case Identifier | SH-6130-04                                  |
| Test Case Name       | <b>SVC Support (optional, if supported)</b> |

|                        |                                                                                                                                                                                                                            |
|------------------------|----------------------------------------------------------------------------------------------------------------------------------------------------------------------------------------------------------------------------|
| Test Purpose           | Test correct addressing/numbering, and signaling channel operation                                                                                                                                                         |
| Standard Requirement   |                                                                                                                                                                                                                            |
| Procedure              | Establish an SVC using predefined and standardized ATM signaling channel and verify NSAP ATM addressing and native E.164 addressing. (NOTE: Additional test cases and details are required for reproducible test results.) |
| Additional Information |                                                                                                                                                                                                                            |
| Expected Results       | NSAP ATM addressing and E.164 addressing work.                                                                                                                                                                             |

|                        |                                                                                                                                                                                                                                                                                                                                                                                                                                                                                                                                                                                                                                                                                                                                                                                                                                                                                                                                                                                                                                                       |
|------------------------|-------------------------------------------------------------------------------------------------------------------------------------------------------------------------------------------------------------------------------------------------------------------------------------------------------------------------------------------------------------------------------------------------------------------------------------------------------------------------------------------------------------------------------------------------------------------------------------------------------------------------------------------------------------------------------------------------------------------------------------------------------------------------------------------------------------------------------------------------------------------------------------------------------------------------------------------------------------------------------------------------------------------------------------------------------|
| Test Case Identifier   | SH-6130-05                                                                                                                                                                                                                                                                                                                                                                                                                                                                                                                                                                                                                                                                                                                                                                                                                                                                                                                                                                                                                                            |
| Test Case Name         | <b>QoS Support for CBR / UBR Traffic</b>                                                                                                                                                                                                                                                                                                                                                                                                                                                                                                                                                                                                                                                                                                                                                                                                                                                                                                                                                                                                              |
| Test Purpose           | Verify correct handling of CBR traffic with presence of UBR (Unspecified Bit Rate) traffic, also know as “Best Effort” traffic                                                                                                                                                                                                                                                                                                                                                                                                                                                                                                                                                                                                                                                                                                                                                                                                                                                                                                                        |
| Standard Requirement   |                                                                                                                                                                                                                                                                                                                                                                                                                                                                                                                                                                                                                                                                                                                                                                                                                                                                                                                                                                                                                                                       |
| Procedure              | <p>The test case is to be run only if CBR functionality is implemented on both the DSLAM and the ATU-R/CPE. Configure the test network as follows:</p> <ul style="list-style-type: none"> <li>• Set up a bi-directional connection on a known VPI/VCI (<i>e.g.</i> VP=1 and VC=35) for CBR traffic. For this connection, the DSLAM setting shall be set to the peak traffic rate (in kbps) or the peak cell rate (PCR) in ATM cells/second, equal to the maximum ATU-R upstream data rate achieved during synchronization.</li> <li>• Set up a bi-directional connection on a separate known VPI/VCI (<i>e.g.</i> VP=2 and VC=35) for UBR traffic. Configure the DSLAM connection setting for the peak traffic rate (in kbps) or the peak cell rate (PCR) in ATM cells/second, equal to the maximum ATU-R downstream data rate achieved during synchronization.</li> <li>• Configure both channels on the Traffic Simulator / Analyzer for O.191 or RFC 2544 generation and analysis.</li> <li>• Configure the ATU-R to loop back traffic.</li> </ul> |
| Additional Information | <ul style="list-style-type: none"> <li>• See test network in Figure xx. The ATM switch or simulator may be removed if the traffic simulator/analyzer is capable of terminating ATM traffic directly from the DSLAM (unless a back-to-back connection proves to be critical or unstable).</li> </ul>                                                                                                                                                                                                                                                                                                                                                                                                                                                                                                                                                                                                                                                                                                                                                   |

|                  |                                                                                                                                                        |
|------------------|--------------------------------------------------------------------------------------------------------------------------------------------------------|
|                  | <ul style="list-style-type: none"> <li>• The loop simulator may be bypassed.</li> <li>• The noise generator may be removed.</li> </ul>                 |
| Expected Results | O.191 or RFC 2544 analysis shall show that only UBR traffic is discarded and that all of the CBR traffic is delivered, if UBR and CBR are implemented. |

|                        |                                                                                                                                                                                                                                                                                                                                                                                                                                                                                                                                                                                                                                                                                                                                                                                                                                                      |
|------------------------|------------------------------------------------------------------------------------------------------------------------------------------------------------------------------------------------------------------------------------------------------------------------------------------------------------------------------------------------------------------------------------------------------------------------------------------------------------------------------------------------------------------------------------------------------------------------------------------------------------------------------------------------------------------------------------------------------------------------------------------------------------------------------------------------------------------------------------------------------|
| Test Case Identifier   | SH-6130-06                                                                                                                                                                                                                                                                                                                                                                                                                                                                                                                                                                                                                                                                                                                                                                                                                                           |
| Test Case Name         | <b>QoS Support for rt-VBR / UBR Traffic</b>                                                                                                                                                                                                                                                                                                                                                                                                                                                                                                                                                                                                                                                                                                                                                                                                          |
| Test Purpose           | Verify QoS operation for real time-Variable Bit Rate (rt-VBR) in presence of UBR traffic                                                                                                                                                                                                                                                                                                                                                                                                                                                                                                                                                                                                                                                                                                                                                             |
| Standard Requirement   |                                                                                                                                                                                                                                                                                                                                                                                                                                                                                                                                                                                                                                                                                                                                                                                                                                                      |
| Procedure              | <p>This test should be performed only if rt-VBR functionality is provided on both the DSLAM and ATU-R/CPE. Configure the test network as follows:</p> <ul style="list-style-type: none"> <li>• Set up a bi-directional connection on a known VPI/VCI (<i>e.g.</i> VP=1 and VC=35) for rt-VBR traffic. Set the peak traffic rate equal to the maximum ATU-R upstream data rate and the sustained traffic rate equal to half the maximum ATU-R upstream data rate.</li> <li>• Set up a bi-directional connection on a separate known VPI/VCI (<i>e.g.</i> VP=2 and VC=35) for UBR traffic. Set the traffic rate equal to the maximum ATU-R downstream data rate.</li> <li>• Configure both channels on the Traffic Simulator / Analyzer for O.191 or RFC 2544 generation and analysis.</li> <li>• Configure the ATU-R to loop back traffic.</li> </ul> |
| Additional Information |                                                                                                                                                                                                                                                                                                                                                                                                                                                                                                                                                                                                                                                                                                                                                                                                                                                      |
| Expected Results       | O.191 or RFC 2544 analysis shall show that all of the cells in the rt-VBR data stream are delivered, if rt-VBR and UBR are implemented. Additionally, a portion of the UBR data stream shall be delivered.                                                                                                                                                                                                                                                                                                                                                                                                                                                                                                                                                                                                                                           |

|                      |                                                                                                              |
|----------------------|--------------------------------------------------------------------------------------------------------------|
| Test Case Identifier | SH-6130-07                                                                                                   |
| Test Case Name       | <b>QoS Support for nrt-VBR / UBR Traffic</b>                                                                 |
| Test Purpose         | Confirm correct QoS functionality for non-real time VBR (nrt-VBR) traffic type                               |
| Standard Requirement |                                                                                                              |
| Procedure            | The following procedure should be used if QoS support is provided for nrt-VBR and UBR traffic. Configure the |

|                        |                                                                                                                                                                                                                                                                                                                                                                                                                                                                                                                                                                                                                                                                                                                                 |
|------------------------|---------------------------------------------------------------------------------------------------------------------------------------------------------------------------------------------------------------------------------------------------------------------------------------------------------------------------------------------------------------------------------------------------------------------------------------------------------------------------------------------------------------------------------------------------------------------------------------------------------------------------------------------------------------------------------------------------------------------------------|
|                        | <p>test network as follows:</p> <ul style="list-style-type: none"> <li>• Set up a bi-directional connection on a known VPI/VCI (<i>e.g.</i> VP=1 and VC=35) for nrt-VBR traffic. Set the peak traffic rate equal to the maximum ATU-R upstream data rate and the sustained traffic rate equal to half the maximum ATU-R upstream data rate.</li> <li>• Set up a bi-directional connection on a separate known VPI/VCI (<i>e.g.</i> VP=2 and VC=35) for UBR traffic. Set the traffic rate equal to the maximum ATU-R downstream data rate.</li> <li>• Configure both channels on the Traffic Simulator / Analyzer for O.191 or RFC 2544 generation and analysis.</li> <li>• Configure the ATU-R to loop back traffic.</li> </ul> |
| Additional Information |                                                                                                                                                                                                                                                                                                                                                                                                                                                                                                                                                                                                                                                                                                                                 |
| Expected Results       | O.191 or RFC 2544 analysis shall show that some UBR and some nrt-VBR cells are delivered, if nrt-VBR and UBR are implemented.                                                                                                                                                                                                                                                                                                                                                                                                                                                                                                                                                                                                   |

|                        |                                                                                                                                                                                                                                                                                                                                                                                                                                                                                                  |
|------------------------|--------------------------------------------------------------------------------------------------------------------------------------------------------------------------------------------------------------------------------------------------------------------------------------------------------------------------------------------------------------------------------------------------------------------------------------------------------------------------------------------------|
| Test Case Identifier   | SH-6130-08                                                                                                                                                                                                                                                                                                                                                                                                                                                                                       |
| Test Case Name         | <b>Loopback at ATU-R</b>                                                                                                                                                                                                                                                                                                                                                                                                                                                                         |
| Test Purpose           | Verify ATM level loopback operation                                                                                                                                                                                                                                                                                                                                                                                                                                                              |
| Standard Requirement   |                                                                                                                                                                                                                                                                                                                                                                                                                                                                                                  |
| Procedure              | <p>Set up a bi-directional connection on a known VPI/VCI, <i>e.g.</i>, VP=0 and VC=35. The ATU-R shall loopback this VPI/VCI on the ATM level.</p> <p>The ATM Cells from generator/analyzer (bit error rate tester or BERT) are filled with a S-PRBS9 sequence. (S-PRBS15 and 23 ?)</p> <p>The downstream channel is loaded up to the capacity of the upstream channel using flat rate distribution (<i>i.e.</i>, constant bit rate, CBR, with cell rate matched to the physical data rate).</p> |
| Additional Information |                                                                                                                                                                                                                                                                                                                                                                                                                                                                                                  |
| Expected Results       | The ATU-R is looped back, BER is less than or equal to $10^{-7}$ when using S-PRBS9 or CER is less than $3.84e^{-5}$ if using either O.191 test cells or RFC 2544 test methodology.                                                                                                                                                                                                                                                                                                              |



|                        |                                                                                                                                                                                                                                                                                                                                                                                                                                         |
|------------------------|-----------------------------------------------------------------------------------------------------------------------------------------------------------------------------------------------------------------------------------------------------------------------------------------------------------------------------------------------------------------------------------------------------------------------------------------|
| Test Case Identifier   | SH-6130-09                                                                                                                                                                                                                                                                                                                                                                                                                              |
| Test Case Name         | <b>F5 OAM Support</b>                                                                                                                                                                                                                                                                                                                                                                                                                   |
| Test Purpose           | Verify that the F5 OAM capability functions correctly                                                                                                                                                                                                                                                                                                                                                                                   |
| Standard Requirement   |                                                                                                                                                                                                                                                                                                                                                                                                                                         |
| Procedure              | <ul style="list-style-type: none"> <li>• Configure the test network for a bi-directional connection on a known VPI/VCI (e.g. VP=0 and VC=35).</li> <li>• Send an F5 OAM segment loopback cell from the network to the CPE/ATU-R.</li> <li>• The OAM F5 Segment loopback request (loopback indication field =1) should specify the OAM loopback of the DSLAM under test in the Loopback Location Identification field (LLID).</li> </ul> |
| Additional Information |                                                                                                                                                                                                                                                                                                                                                                                                                                         |
| Expected Results       | Confirm that a response cell is received from the DSLAM.                                                                                                                                                                                                                                                                                                                                                                                |

#### 6.1.4 ATM Interoperability Test description

If both DSLAM and DUT support auto-configuration according to The Broadband Forum Technical Report TR-037, an ATM PVC is configured on the DSLAM. If at least one of the DSLAM and DUT do not support auto-configuration, a ATM PVC is configured on both DSLAM and DUT. The test reports whether the ATM PVC comes up.

## 6.2 Interoperability test for SHDSL bridges and routers

### 6.2.1 Test purpose

The purpose of this test is to show that a SHDSL bridge or router is interoperable with a DSLAM / BAS combination. Interoperability can be proven in bridge and routing modes with different encapsulation methods like RFC2684, PPPoA and PPPoEoA and with different multiplexing methods VC muxed or LLC muxed.

### 6.2.2 Test set-up

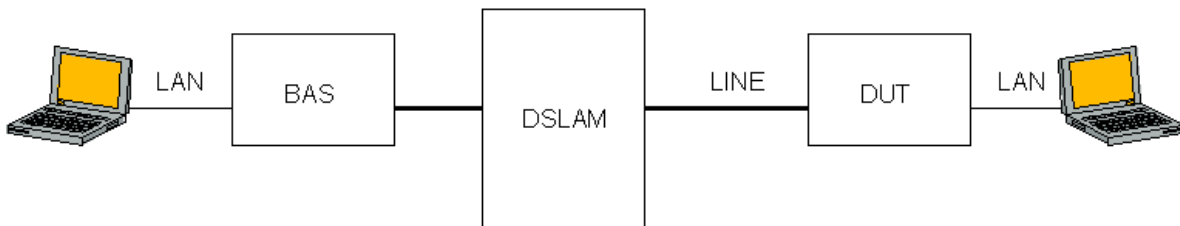

**Figure 16: Interoperability test set-up for SHDSL bridges and routers**

The test set-up shown in Figure 16 includes a BAS in the test set-up. If the DSLAM includes BAS functionality, the BAS can be omitted and the DSLAM is directly linked to the traffic analyzer. The SHDSL line interfaces are interconnected with a short twisted pair cable.

### 6.2.3 Test description

The following basic series of tests can be performed depending on the support by DUT and DSLAM/BAS:

| Test No.<br><b>SH6230</b> | DUT acts as a ... | ATM line encapsulation is ... | VC multiplexing is ... |
|---------------------------|-------------------|-------------------------------|------------------------|
| .1                        | Bridge            | RFC2684                       | LLC                    |
| .2                        | Bridge            | RFC2684                       | VC                     |
| .3                        | Bridge            | PPPoA (RFC2364)               | LLC                    |
| .4                        | Bridge            | PPPoA (RFC2364)               | VC                     |
| .5                        | Router            | RFC2684                       | LLC                    |
| .6                        | Router            | RFC2684                       | VC                     |
| .7                        | Router            | PPPoA (RFC2364)               | LLC                    |
| .8                        | Router            | PPPoA (RFC2364)               | VC                     |
| .9                        | Router            | PPPoE (RFC2516 and RFC2684)   | LLC                    |
| .10                       | Router            | PPPoE (RFC2516 and RFC2684)   | VC                     |

In the tests with PPPoE, the PPPoE session is initiated on the router. Per executed test, it is reported whether LAN traffic can be sent between the traffic generators or not.

|                        |                                                                                              |
|------------------------|----------------------------------------------------------------------------------------------|
| Test Case Identifier   | SH-6231-10                                                                                   |
| Test Case Name         | PPPoE                                                                                        |
| Test Purpose           | Verify PPPoE end-to-end connectivity                                                         |
| Standard Requirement   |                                                                                              |
| Procedure              | Terminate PPPoE session, and verify connectivity by passing traffic over this PPPoE session. |
| Additional Information |                                                                                              |
| Expected Results       | Transmitted packets are received.                                                            |

|                      |                                      |
|----------------------|--------------------------------------|
| Test Case Identifier | SH-6231-20                           |
| Test Case Name       | PPPoA                                |
| Test Purpose         | Verify PPPoA end-to-end connectivity |
| Standard Requirement |                                      |

|                        |                                                                                            |
|------------------------|--------------------------------------------------------------------------------------------|
| Procedure              | Terminate PPPoA session and verify connectivity by passing traffic over the PPPoA session. |
| Additional Information |                                                                                            |
| Expected Results       | Transmitted packets are received                                                           |

**6.3 Performance test for SHDSL bridges and routers**

**6.3.1 Test purpose**

The purpose of this test is to measure the bridging and routing forwarding performance of the DUT.

**6.3.2 Minimum requirements**

The DSLAM can switch ATM PVCs between different DSL lines. It supports as well the maximum line speed available on the DUTs on its SHDSL line interface. The traffic generators have sufficient performance to send, receive and analyze 64 byte IP packets between each other over the LAN at the maximum rate on the SHDSL line divided by 512 bps (64B x 8 bits/B). This exceeds the maximum forwarding rate possible over the SHDSL lines, since encapsulation overhead is not counted.

**6.3.3 Test set-up**

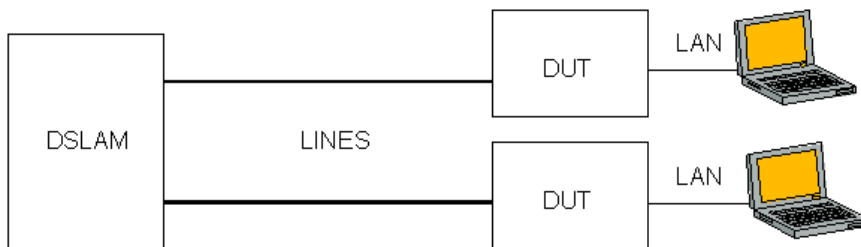

**Figure 17: Performance test set-up for SHDSL bridges and routers**

The SHDSL line interfaces are interconnected with a short twisted pair cable at the maximum available line speed, supported on the DUT. The DSLAM is configured to switch the data between its 2 SHDSL line interfaces.

**6.3.4 Test description**

One traffic analyzer sends a flat IP ping request with a packet size of 64 bytes to the other traffic analyzer. Flat ping means that ping requests are sent without waiting for the reply of the previous ping until K pings are not answered. K is the window size and is set for this test at 100 packets.

Over a period of 5 minutes, the total number of correctly received ping packets is measured. The forwarding rate is reported in packets per second as this value divided by 150 (300 seconds / 2 packets (ping request and ping reply)).

This series of tests are done for the following combinations of routing/bridging, encapsulation and VC multiplexing:

| Test No.<br><b>SH6340</b> | DUT acts as a ... | ATM line encapsulation is ... | VC multiplexing is ... |
|---------------------------|-------------------|-------------------------------|------------------------|
| .1                        | Bridge            | RFC2684                       | LLC                    |
| .2                        | Bridge            | RFC2684                       | VC                     |
| .3                        | Router            | RFC2684                       | LLC                    |
| .4                        | Router            | RFC2684                       | VC                     |

|                        |                                                                                                                                                                                                                                                                                                                                                                                                                               |
|------------------------|-------------------------------------------------------------------------------------------------------------------------------------------------------------------------------------------------------------------------------------------------------------------------------------------------------------------------------------------------------------------------------------------------------------------------------|
| Test Case Identifier   | SH-6340-05                                                                                                                                                                                                                                                                                                                                                                                                                    |
| Test Case Name         | RFC2684 end-to-end connectivity                                                                                                                                                                                                                                                                                                                                                                                               |
| Test Purpose           | Verify IP routing/bridging                                                                                                                                                                                                                                                                                                                                                                                                    |
| Standard Requirement   |                                                                                                                                                                                                                                                                                                                                                                                                                               |
| Procedure              | Configure the test environment including the ATU-R and a computer so that the ATU-R/CPE Ethernet port terminates a bridge section. The second termination of the bridge section should be implemented at an appropriate device within the testing environment ( <i>e.g.</i> , DSLAM, PoP). Pass IP packets over the complete bridge section and verify the proper reception at the destination ( <i>e.g.</i> , PoP, Host PC). |
| Additional Information |                                                                                                                                                                                                                                                                                                                                                                                                                               |
| Expected Results       | Transmitted packets are received                                                                                                                                                                                                                                                                                                                                                                                              |

## **6.4 Interoperability test for SHDSL CPEs with CES capabilities**

### **6.4.1 Test purpose**

The purpose of this test is to show that the DUT can be used for leased line services over an ATM network with DSLAMs as used in the test. The test focuses in particular on Circuit Emulation Service (CES) for E1 Nx64Kbit/s (fractional E1) and unstructured E1 (2.048Mbit/s) services as defined in ATM Forum "Circuit Emulation Service Interoperability Specification Version 2.0" af-vtoa-0078.000.

Interoperability issues are CBR support, network clock forwarding and jitter transfer. Asynchronous clocking mode with adaptive clock recovery is not included in the tests, since this clocking mode does not require any clocking information from the network.

### 6.4.2 Minimum requirements

The DSLAM can switch ATM PVCs between different DSL lines.

### 6.4.3 Test series set-up 1

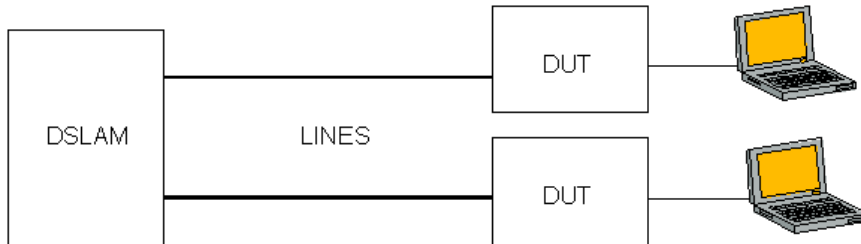

**Figure 18: Interoperability test set-up for SHDSL CPEs with CES capabilities**

The SHDSL line interfaces are interconnected with a short twisted pair cable at the maximum available line speed, supported on the DUT. The DSLAM is configured to switch the data between its 2 SHDSL line interfaces.

### 6.4.4 Test Series 1 description

The first series of tests checks whether circuit data can be transported error-free over the ATM network. Tests can be performed in E1 Nx64K mode with synchronous clocking and G703 or serial interface types depending on supported interface types on the DUT. Serial interface types may include V35, V36, X21 and RS530 interfaces. Tests in unstructured E1 mode can be performed with different clocking modes again with G703 or serial interface types.

| Test No.<br>SH6440 | Clocking mode | Service                                                                                   |
|--------------------|---------------|-------------------------------------------------------------------------------------------|
| .1                 | Synchronous   | E1 Nx64K on G703 2Mbit/s interface, time slots 0 through 3 and 16 are sent over the line. |
| .2                 | synchronous   | E1 Nx64K on G703 2Mbit/s interface, time slots 0 through 30 are sent over the line.       |
| .3                 | synchronous   | Nx64K serial interface (V10/V11) at 256Kbit/s                                             |
| .4                 | synchronous   | Nx64K serial interface (V10/V11) at 1984Kbit/s                                            |
| .5                 | synchronous   | unstructured E1 on G703 2Mbit/s interface                                                 |

|    |                                       |                                           |
|----|---------------------------------------|-------------------------------------------|
| .6 | asynchronous with SRTS clock recovery | unstructured E1 on G703 2Mbit/s interface |
| .7 | synchronous                           | 2Mbit/s on serial interface (V10/V11)     |
| .8 | asynchronous with SRTS clock recovery | 2Mbit/s on serial interface (V10/V11)     |

The tests report whether error-free traffic can be received between the traffic generators. Also the line speed is reported.

**6.4.5 Test series set-up 2**

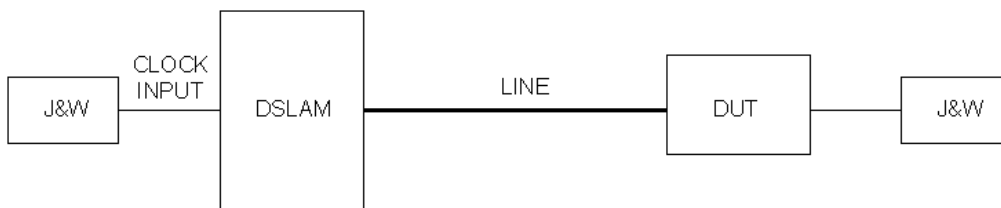

**Figure 19: Jitter test set-up for SHDSL CPEs with CES capabilities in synchronous clocking mode**

The SHDSL line interfaces are interconnected with a short twisted pair cable at the maximum available line speed, supported on the DUT. The input signal is applied on the clock input of the DSLAM.

**6.4.6 Test Series 2 description (If equipment is available for such measurements)**

The second series tests verify whether the jitter transfer characteristics are within ITU-T G.823 and G.736 limits for synchronous modes. The jitter output signal is measured on the G703 2Mbit/s interface of the DUT. The relevant section in the ITU-T recommendation G.823 of March 1993 is 3.1.3. The relevant section in ITU-T recommendation G.736 of March 1993 is 6.3.1.

Tests can be performed on G703 interfaces in E1 Nx64K mode and unstructured E1 mode.

| Test No. | Clocking mode | Service                                                                                   |
|----------|---------------|-------------------------------------------------------------------------------------------|
| SH6460   |               |                                                                                           |
| .1       | synchronous   | E1 Nx64K on G703 2Mbit/s interface, time slots 0 through 3 and 16 are sent over the line. |

|    |             |                                           |
|----|-------------|-------------------------------------------|
| .2 | synchronous | unstructured E1 on G703 2Mbit/s interface |
|----|-------------|-------------------------------------------|

The tests report the jitter transfer function and whether it is within the limits defined in ITU-T G.736.

**6.4.7 Test set-up 3**

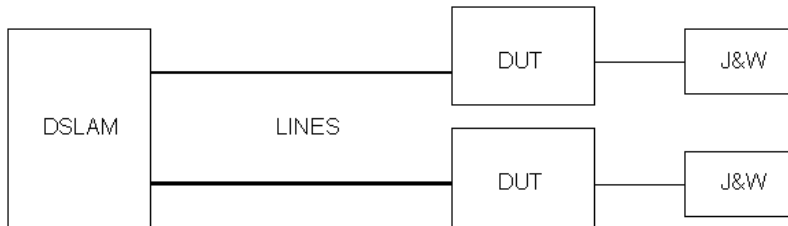

**Figure 20: Jitter test set-up for SHDSL CPEs with CES capabilities in asynchronous clocking mode.**

The SHDSL line interfaces are interconnected with a short twisted pair cable at the maximum available line speed, supported on the DUT. The DSLAM is configured to switch the data between its 2 SHDSL line interfaces. The input jitter signal is applied on a G703 2Mbit/s interface of the first DUT.

**6.4.8 Test 3 description**

The third test verifies whether the jitter transfer characteristics are within ITU-T G.823 and G.736 limits in asynchronous clocking mode with SRTS clock recovery. The output jitter is measured on the G703 2Mbit/s interface of the second DUT. The relevant section in the ITU-T recommendation G.823 of March 1993 is 3.1.3. The relevant section in ITU-T recommendation G.736 of March 1993 is 6.3.1.

| Test No. | Clocking mode                         | Service                                   |
|----------|---------------------------------------|-------------------------------------------|
| SH6480   |                                       |                                           |
| .1       | Asynchronous with SRTS clock recovery | Unstructured E1 on G703 2Mbit/s interface |

The tests report the jitter transfer function and whether it is within the limits defined in ITU-T G.736.

End of specification.